

plumis

Automist Smartscan
Hydra[®] Design, Installation,
Operation and Maintenance
(DIOM) Manual

Version 3



Contents

Definitions.....	6
INTRODUCTION TO SMARTSCAN HYDRA.....	7
Introduction	8
Automist Smartscan Hydra	9
System Diagram	10
Water Supply Components (in required order).....	11
Scope	13
Compliance to BS 8458:2015	14
Roles and Responsibilities.....	15
Initial Consultation and Requirements Specification.....	16
The Automist Design Specification.....	17
System Enhancements	18
General	18
Type of building and occupancy	18
Using Automist as a Compensatory Feature	20
Higher fire risk and impact factors.....	20
Occupancy profile - vulnerable people risk factors.....	21
Improving Automist's performance and reliability.....	21
Resilience and Robustness.....	22
DESIGN AND SPECIFICATION.....	24
Introduction	25
Fire Tests and Limits of Application	25
Extent of Automist protection	26
Automist Design Guidelines.....	27
Spray head Location	28
The Automist spray head	28
Obstructions	31
How Automist is affected by obstructions	33
Preferred Positions	34
Primary Objective	35
Secondary Objective	36
Tertiary Objective	37
Hydraulic Calculations	40
Discharge performance and duration	40
Increasing the visibility of spray heads.....	40

Installing two Automist systems in parallel for increased density or robustness.....	41
Water Supplies.....	41
Backflow Prevention	42
Components	42
Watermist nozzle (Automist spray head)	43
Hoses, Piping, fittings and cables	44
Fittings	44
Hose General	44
Hose with 1/4" Inner Diameter (Up to 20m in total length)	45
Hose with 5/16" Inner Diameter (Up to 40m in total length)	45
Stainless Steel Piping (alternative to high pressure hose).....	46
Hoses, Piping support.....	46
Hydra Data & Alarm Cables.....	46
Detection Devices.....	48
Plumis Wireless Multisensor Alarm (DT01)	49
Compatible third party detectors/alarms.....	49
Nittan EVC-DP Dual Optical Detector	50
Integration with other alarm systems.....	51
1) Domestic	52
2) Residential.....	54
Transmission of alarm signals to alarm receiving centres	55
Controller	55
Valves.....	56
Electrically operated devices.....	56
Strainer	56
Fire pumps	56
Automist Pump Specification	57
Pump with an output relay (AP10)	57
Automatic test and monitoring facilities	58
Electrical design and installation.....	58
Additives	58
Trunking and Pump Enclosures.....	58
INSTALLATION	59
Installation Procedure	60
A) First Fix - Preparing the site	61
Mains Electricity Installation.....	61

Mains Water Installation.....	64
High Pressure Hoses Installation.....	65
Data Cables Installation.....	66
Fire Stopping.....	66
Detector and/or alarm installation.....	67
Plumis Wireless Smoke Heat Alarm (DT01) Installation	69
B) Second Fix.....	70
High pressure hose pressure test.....	70
Installing the controller.....	70
Installing the spray head(s) and pump.....	73
Connecting the Water Supply	78
C) Commissioning.....	81
The Automist Smartscan Hydra Controls.....	82
Commissioning Procedure.....	84
1. Commissioning addresses stage.....	84
2. Commissioning alarms and zoning stage	85
3. Commissioning discharge stage.....	87
4. Drainage stage.....	90
Online logbook	92
Warning Labels	92
Re-enter Commissioning Mode After Successful Commissioning	94
Alarm Test Mode	94
Compliance Certificate.....	94
Documentation.....	95
Post-installation checklist – Key points for installers and Building Control	96
Power supply	96
Water Supply.....	96
Pump & spray head placement	96
Head Placement	96
High Pressure Hose.....	97
Stainless Steel Piping (alternative to high pressure hose).....	97
Fire Stopping.....	97
Coverage.....	97
Documentation.....	97
OPERATION.....	98
What to do if the system activates?	99

MAINTENANCE	100
Maintenance	101
1. Visual inspection	101
2. Service the detectors/alarms.....	101
3. Authorised Reseller Installer inspection.....	102
4. Software update process	102
5. Recommissioning.....	103
Software update process	104
Cleaning.....	106
Repair.....	106
Troubleshooting	107
Plumis UK technical support.....	111
Returning equipment to Plumis – RMA (Return Material Authorisation)	111
Warranty.....	112
APPENDIX A	114
APPENDIX B	116
APPENDIX C	119
Example Design Specification.....	120
APPENDIX D	121

Definitions

Automatic nozzle a mechanically trigger nozzle as used on a pressurised wet pipe or dry-pipe system where a thermal frangible or fusible link allows for water discharge from nozzle.

Automist Commissioner Installer is responsible for commissioning the installation and confirming that it has been completed in line with these guidelines at the end of the installation and capturing all the key information which is used to populate the commissioning form.

Automist Designer is responsible for creating the design specification for Automist (layout drawings, interaction with other systems) and liaising with the customer in response to the requirements specification.

Design Specification a document produced by the Automist Designer which interprets the Requirements Specification and this DIOM into a layout drawing explaining the extent of coverage and any other resilience or robustness requirements resultant from that analysis.

Domestic client people who have construction work carried out on their own home, or the home of a family member that is not done as part of a business

Electronic Nozzle a nozzle which might be open in a standby condition, but which once triggered, will further process data to decide whether to point at the fire or shut flow to it. It will not act simply in a binary manner (open/close) from an electrical input. Not yet captured by standards.

Pre-installer an electrician, plumber, or multi-trade who is involved in providing water and power to the Automist system but is not trained or authorised to commission the system.

Requirements Specification a document provided by the client which explains the need for suppression and the extent of coverage of suppression as a result of this need. This document allows the Designer to produce a Design Specification.

Residential client organisations or individuals for whom a construction project is carried out and involves multiple occupancies

INTRODUCTION TO SMARTSCAN HYDRA

Introduction

- READ ALL OF THIS MANUAL. It is intended for the use of designers, engineers, architects, surveyors, contractors, authorised reseller installers (ARIs) and authorities having jurisdiction.
- To avoid hazards, all installation procedures and maintenance must be carried out by an Authorised Automist Installer (with a valid training certificate for the role they are performing).
- Do not install Automist Smartscan Hydra outside these guidelines. Installing Automist outside these guidelines could make you responsible for deaths or injuries.
- Retain this guide for later use.
- The content in this manual may differ from the product and is subject to change without prior notice. It is recommended to check you have the latest version of DIOM from Plumis website before proceeding.
- Follow all warnings, cautions and instructions contained in this manual.
- This device not to be used by persons (including children) with reduced physical, sensory, or mental capabilities, or lack of experience and knowledge, unless they have been given supervision or instruction (excluding children).
- The execution of its provisions will be entrusted to appropriately qualified and experienced people, for whose use it has been produced.
- Once installed, complete and submit an installation and commissioning form to Plumis.
- Automist Smartscan Hydra requires recommissioning at least annually to provide effective protection.
- When this product has reached the end of its serviceable life, it will become an electrical waste (WEEE), so it must not be disposed in landfill. Consult the Plumis website for guidance on disposal.
- The system operates with a dangerous voltage and high-pressure water jet. There is therefore risk of electrocution or injury to eyes from the water jet when installing the system. Suitable PPE must be used to avoid these hazards!
- Compliance with this guidance document cannot confer immunity from legal obligations.

Disclaimer: This information is not intended to be a comprehensive guide to all the aspects of the UK building regulations or the UK Fire Safety Order. Whilst every care has been taken to ensure that the contents of this document are correct at the time of publication, it should never be used as any form of substitution for the guidance documents. It should be noted that there may be specific additional requirements dependent upon local authority building regulations and/or fire authority.

Automist Smartscan Hydra

Watermist fire suppression systems have demonstrated their value in assisting the protection of life and property for many years. A correctly designed, installed, and properly maintained Automist fire suppression system can detect, suppress, and control a fire at an early stage of development, and activate an alarm. The automatic operation of the system rapidly reduces the rate of production of heat and smoke, allowing more time for the occupants to escape to safety or be rescued.

The controller continually monitors the thermopile sensors by reading the temperature while parked, ensuring that all heads are ready to operate. When triggered by a Plumis multi-sensor wireless alarm or a wired detector, all the linked spray heads will begin scanning. They start measuring the temperatures within the room using an infrared thermopile sensor. The scan is looking for an exceptionally high temperature reading, or a differential increase between scans. Once the temperature exceeds a threshold that head is deemed to have successfully located a fire. All heads which locate a fire during a scan are then compared to see which has the best view.

The selected spray head will lock onto the selected location, and activate the high-pressure pump, driving mains water through the unique nozzle unit, quickly directing a dense fog into the location of the fire. The high momentum vertical spray orientation with a horizontal trajectory is designed so fires can be saturated with a turbulent flow of mist, suppressing the fire.

Watermist has a different principle of firefighting to traditional sprinklers which suppress fires by wetting surfaces and directly cooling the flames with large water drops. Water mist uses fine droplets, which evaporate at the base of the fire, to extract heat and displace the oxygen fuel. This results in fire control, suppression, or extinguishment. Our spray heads are wall mounted (around light switch height) to avoid ineffective evaporation in the hot layer in the ceiling and the upward flow of hot combustion products. Automist leverages the natural turbulence the fire creates and seeks to ensure watermist is entrained in the fire plume by targeting mist directly at the base of the fire.

The provision of Automist does not negate the need for other fire precautions or practical measures, which can include structural fire resistance, escape routes, smoke or fire detectors and safe housekeeping practices. Even with the installation of Automist, normal actions on the discovery of a fire need to be taken, such as immediate evacuation and the calling of the fire and rescue service.

Automist maintenance is not complex but is essential. It is important that owners and occupiers pay particular attention to the details within, such as the avoidance of obstructions to the watermist nozzle (see page) and contacting an Authorised Automist Installer to address fault conditions (see page 107).

System Diagram

1. Water Regulations Approval Scheme (WRAS) approved isolation valve
2. Automist Smartscan Hydra supply label & cable tie
3. ¾" single check valve (AC03)
4. Filter (AC03) and bracket (P0001_D)
5. Pressure reducing valve (PRV) (P0001) (AC03)
6. ¾" stainless steel inlet hose (AC03)
7. Automist Smartscan Hydra pump unit (AP08)
8. Automist Smartscan Hydra controller (CT01)
9. Quick connect with test point for pressure gauge (AC03)
10. High pressure outlet hose (or high-pressure stainless-steel pipe)
11. Assembled Automist Smartscan Hydra head(s) (SH11)
12. Plumis wireless multi-sensor alarm(s) (DT01)
13. Specified wired detector (Apollo Orbis or A1R)
14. Adhesive label set (not shown) (AC03)

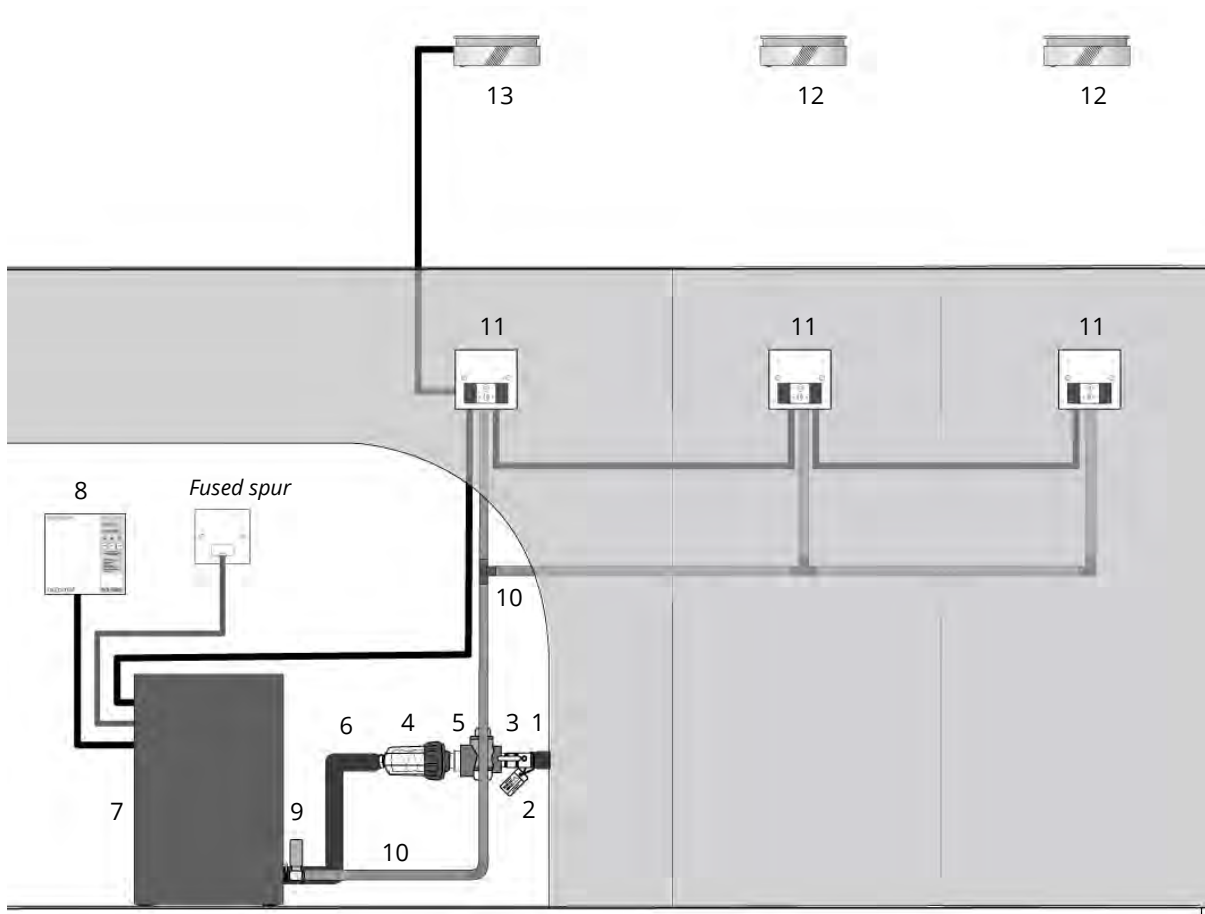

Figure 1: Automist Smartscan Hydra System Diagram

Water Supply Components (in required order)

Assembly Order

1. 3/4" BSP water supply
 - i. WRAS approved isolation valve
 - ii. Non return valve
An additional hose (vii) can be added between ii and iii for when space is tight
 - iii. Pressure reducing valve (PRV)
 - iv. BSP 3/4" nipple
 - v. Rubber washer
 - vi. Filter
 - v. Rubber washer
 - vi. Hose
 - vii. Rubber washer

2. Pump

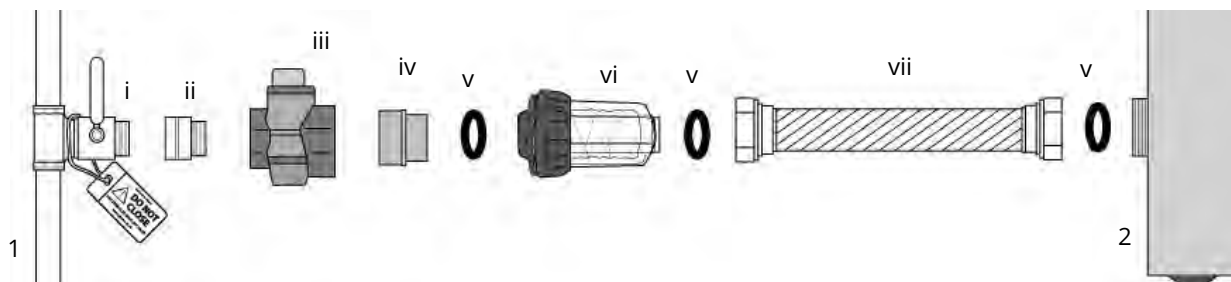
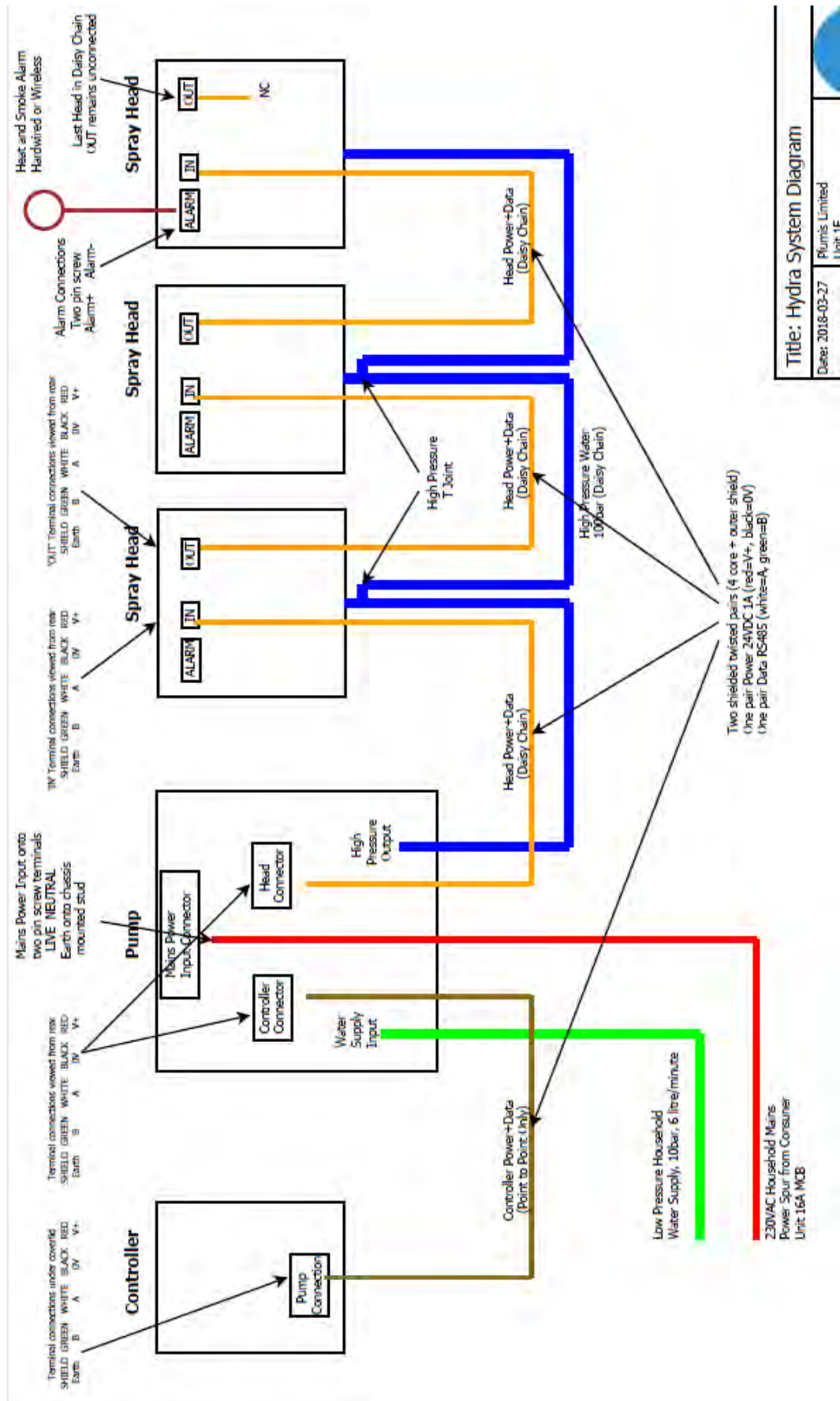

Figure 2: Automist Smartscan Hydra System Water Supply Components



Title: Hydra System Diagram
Date: 2018-03-27
Plumis Limited
Unit 1F

Figure 3: Automist Hydra system diagram highlighting electrical and hydraulic connections

Scope

This Design, Installation, Operation and Maintenance (DIOM) Manual gives recommendations for the design, installation, water supplies, commissioning, maintenance, troubleshooting, and testing of Automist Smartscan Hydra when installed in residential and domestic occupancies. It primarily covers the systems use for life safety but might also provide property protection.

Automist Smartscan Hydra has been independently, third party, tested by Exova Warrington Fire to confirm that it meets the performance requirements of BS 8458 2015, as validated by BSI Verification Certificate VC 71258.

Automist is typically used for BS 8458 equivalent domestic or residential occupancy, up to a maximum height of 45 m building height. If the type of building is not listed (see page 18), or for buildings over 45 m, then the Authority Having Jurisdiction (AHJ) should be consulted to agree whether additional measures are needed (see page 18), or whether an alternative system (e.g. BS 8489 or EN 12845) is more appropriate.

In some buildings or parts of buildings, a higher level of protection might be required than that provided in this DIOM. In buildings where there is a mix of residential, non-residential, and commercial use (e.g. where flats are above shops, car parks, bin stores, offices, and retail units), it is generally appropriate to protect the residential parts using this DIOM and the non-residential parts using BS 8489 or BS EN 12845.

Here are the key differences between Automist and a traditional watermist system:

	Traditional watermist system	Automist
Activation	Glass bulb or fusible link (mechanical thermal)	Electronic trigger based on smoke detection and thermal sensing
System design	Wet pipe (i.e. one that is permanently charged with water)	Non pressurised (open) dry pipe
Nozzle location	Ceiling (or close to ceiling) mounted	Wall mounted at 1.3m height
Discharge performance	The system should be capable of providing pressures and flow rates to permit all the watermist nozzles in the fire test room or largest compartment, whichever is the greater, up to a maximum area of operation (AMAO) of 64 m ² , to operate simultaneously at not less than the greater of: a) the nozzle pressure given by the pass criteria determined by the test in Annex C of BS 8458; or b) the approval listed discharge performance.	The electronic activation ensures only one watermist nozzle activates with not less than the pressure and flow given by the pass criteria determined by the test in Annex C of BS 8458.
Minimum run time	10 minutes	30 minutes (connected to mains water)
Ceiling height	3.5m or 5.5m height depending on fire test results according to Annex C of BS 8458	3.5m height depending on fire test results according to Annex C of BS 8458. Higher ceiling heights if supported by fire engineering justification

Compliance to BS 8458:2015

The table below helps readers understand how Automist complies with the applicable clauses of BS8458:2015 and where to find further details in this DIOM:

BS 8458 Clause		Automist	
Section	Sub Section	Compliant	Detail
1 - Scope		Alternative	See page 13
2 - Normative references		n/a	n/a
3 - Terms and definitions		n/a	n/a
4 - Preliminary work and consultation	4.1 - Initial consultations	Yes	See page 16
	4.2 - Consultation	Yes	See page 16
	4.3 - Category of system	Yes	See page 18
	4.4 - Cylinder-based systems	n/a	n/a
	4.5 - Use of watermist systems as a compensatory feature	Yes	See page 20
	4.6 - Special circumstances	Yes	See page 18
5 - System actuation		Alternative	See page 13
6 - Design	6.1 - Fire tests	Yes	See page 25
	6.2 - Limits of application	Yes	See page 25
	6.3 - System design	Alternative	See page 25 and 27
	6.4 - Extent of watermist system protection	Yes	See page 26
	6.5 - Hydraulic calculations	Yes	See page 40
	6.6 - Discharge performance	Yes	See page 40
	6.7 - Discharge duration	Yes	See page 40
	6.8 - Water supplies	Alternative	See page 41
	6.9 - Backflow prevention	Yes	See page 42
	6.10 - Watermist nozzle coverage and location	Alternative	See page 27 and 28
	6.11 - Components	Alternative	See page 42
	6.12 - Electrical design and installation	Yes	See page 58
	6.13 - Additives	Yes	See page 58
7 - Installation, commissioning, and documentation	7.1 - Installation	Yes	See page 59
	7.2 - Commissioning	Yes	See page 84
	7.3 - Documentation	Yes	See page 95
	7.4 - System data label	Alternative	See page 93
8 - Maintenance	8.1 - Inspecting and testing after commissioning and whilst in service	Yes	See page 101
	8.2 - Reinstatement of the system	Yes	See page 101
	8.3 - Logbook	Alternative	See page 92

Roles and Responsibilities

This Section describes the roles and responsibilities relevant to the installation of Automist.

External parties to installer's scope

Name	Role and responsibility
Domestic client (people who have construction work carried out on their own home, or the home of a family member that is not done as part of a business)	Appoints the Authorised reseller installer (ARI) and any pre-installers. A client should prepare a clear Requirements Specification (see page 17). A domestic client can choose to have a written agreement with an architect, or their main contractor to carry out the client duties. Should provide the accurate scale drawings of the area which requires protection.
Residential client (organisations or individuals for whom a construction project is carried out)	Appoints the Authorised reseller installer (ARI) and any pre-installers. A client should prepare a clear Requirements Specification (see page 17). They must ensure relevant information is prepared and provided to other appointed duty holders. Should provide the accurate scale drawings of the area which requires protection.
Pre-installer (e.g. electrician, plumber, or multi-trade)	The first fix (see page 61), installation of the power and water supply, must be carried out by a qualified electrician and plumber. Electrical work must meet the NICEIC standards and plumbing work must meet the standards of the Chartered Institute of Plumbing and Heating Engineers (CIPHE). Approved Contractor Persons (ACPs) of the CIPHE can self-certify under the Water Supply (Water Fittings) Regulations 1999 and the Water Bylaws 2000 (Scotland).

Internal parties to installer's scope

Only suitably trained and certified individual Authorised Reseller Installers (ARIs) are permitted to carry out design and/or commissioning work of Automist. These partners regularly design, survey, install and service Automist in a wide variety of projects, and each is fully trained and audited to ensure that high standards are maintained. Not all registrations are qualified to do all types of work. There are two types of ARI Automist competence (Designer and Commissioner Installer):

Name	Role and responsibility
Designer	This person has a good understanding of the building regulations and associated guidance documents, such as ADB and BS 9991, is responsible for creating the design specification for Automist (layout drawings, interaction with other systems) and liaising with the customer in response to the requirements specification. Designers shall be fully trained to assess the best location for the Automist spray heads, factoring in the shape and type of room and potential fire loads. They must update the design if the Commissioner Installer identifies any inaccuracies on site which may obstruct the spray discharge.

Commissioner Installer	<p>This hands-on skilled tradesperson performs the second fix (see page 70), installation, commissioning, servicing, and maintenance. They must have a good understanding of electrical work, plumbing, fire alarms and fire-stopping to fulfil their role successfully. Installers have a thorough knowledge of Automist's performance capabilities and restrictions on where items can be placed, ensuring they can recognise and deal with any issues or changes on site. They must take responsibility that the installation has been completed in line with these guidelines at the end of the installation and capture all the key information which is used to populate the commissioning form. The commissioner installer must consult with the Designer if they deviate from their design in a way which may affect the performance.</p> <p>IMPORTANT! Only fully trained 'installers' who have been audited can take responsibility for an installation sign off.</p>
------------------------	--

Initial Consultation and Requirements Specification

Before attempting the design of an Automist system for a specific property, the following factors should be considered by the designer to ensure that the Automist design is suitable for the proposed application, obtaining specialist advice where necessary:

- a) the type of building to be protected and the areas of the building to be protected;
- b) the type of occupancy of the property (see page 18);
- c) any legal requirements determining the use of fire suppression, or whether elective, and the guidance documents used to determine the requirements for fire suppression;
- d) the water and power supply availability; and
- e) any special circumstances which may lead to system enhancements (see page 18).

The client (and/or their representatives) should consult with all relevant stakeholders regarding the requirements for Automist. Some premises may have several stakeholders as authorities having jurisdiction (AHJs). These may have requirements on life safety, on property protection, on business continuity, on heritage preservation, and on environmental protection. If these apply to the property where Automist is being specified, they should be consulted as some of them may impose additional requirements to the system to satisfy their performance expectations. These include:

- a) water undertaker or licensed water supplier;
- b) fire authority;
- c) licensing authority;
- d) building control body;
- e) conservation regulators;
- f) insurer(s) of the building and its contents;
- g) client, and their representatives, e.g. consultant(s), architect, fire engineer, surveyor, building owner, building management, and/or the responsible person for the building.

It is the responsibility of the client to provide the Authorised Reseller Installer (ARI) designer and commissioner installer with a Requirements Specification for them to design and install Automist, including whether any enhancements (see page 18) to the system are necessary.

IMPORTANT! This specification must originate from the Client, their Main Contractor, or their appointed Fire Engineer as they are the only participants with the knowledge required of the building and occupancy

risks, and the overall Fire Safety Plan and the role that Automist plays in assuring safety: this responsibility should not be devolved to Automist Designer. It is the responsibility of the Client, or their appointed representative, to consider these, and communicate the results of their deliberations to the Automist Designer / Installer so that these can be accounted for within the design.

Using Automist to meet Building Regulations

Schedule B of the Building Regulations defines the functional requirements of buildings with respect to B1 means of escape; B2 internal lining spread; B3 internal fire spread; B4 external fire spread and B5 firefighting access and safety. Suppression is typically used so that buildings can meet requirements B1, B3 and B5. BS 9991 or a fire engineering analysis can provide guidance on the adequate use of Automist given its guidance on BS 8458 water mist systems.

Additionally, Regulation 7 requires building work to be carried out with '*adequate and proper materials*' which '*are appropriate for the circumstances in which they are used*' '*so as adequately to perform the functions for which they are designed; and in a workman like manner*'. Materials include manufacturers products, equipment, and systems.

Using Automist as an elective fire safety

In cases where Automist is being used solely as an elective means to improve the levels of fire safety and is not a requirement for Building Regulations or general minimum statutory life safety standards. The design, performance, and implementation of Automist is completely at the client's discretion and are not governed by statutory prescriptive requirements. The performance and/or operation of the suppression system in this case will not be relied upon for adequate minimum standards of safety within the accommodation.

The Automist Design Specification

The Authorised Reseller Installer (ARI) designer should consult with stakeholders to develop and produce the Design Specification in line with the client's Requirement Specification (see page 16). It is the responsibility of the Automist Designer to ensure that the specification is appropriate for the Requirement Specification provided.

The specification for the design should include the following information:

- a) building/occupancy types (see page 18);
- b) areas of the building to be protected;**
- c) water supply requirements and verification measures;
- d) how Automist interacts with fire alarm system (see page 48);
- e) details of any enhancements to Automist (see below); and
- f) where a fire strategy relies upon the design of the automatic water fire suppression system (AWFSS), a version-controlled copy of that fire strategy, including sufficient detail to understand the fire safety objectives, relationships, and dependencies.

An example of a Automist Design Specification is available in Appendix C (see page 119).

IMPORTANT! Any deviation from this DIOM must be agreed by the Authority Having Jurisdiction in writing.

System Enhancements

General

For a water-based fire suppression system to work reliably it will invariably require water and/or power to be available at the time of the fire. There are two ways to improve the reliability of supplies, through:

- Resilience: the quality of being able to return quickly to a good condition after disruption (e.g. remote monitoring or regular maintenance, and a service contract with an appropriate response time).
- Robustness: the quality of being healthy and therefore unlikely to fail (e.g. dual power supply or a battery backup).

Depending on the type of building, the ease of escape or of fire rescue access, Automist might have enhanced features implemented to address these aspects of additional risk identified in the Requirements Specification (see page 16). For example:

- a) type of building/occupancy (see page 18);
- b) compensatory features (see page 20);
- c) higher fire safety risk and impact factors (see page 20); and
- d) occupancy profile - vulnerable people (see page 21).

Type of building and occupancy

The Automist Designer should at an early stage determine which category of system is applicable, as this affects various design considerations, such as the water requirements for the system. The AHJ(s) should be consulted to agree which type of building applies, whether any other enhancements to the system are applicable and whether Automist is suited for the type of building proposed.

Type of Occupancy	Description of building/occupancy
Domestic occupancy	Single family dwellings such as: <ul style="list-style-type: none"> • dwelling house; • Individual flat;^{A)} • Individual maisonette • transportable home Houses of multiple occupation (HMOs) ^{A)} Bed and breakfast accommodation ^{A)} Boarding houses ^{A)}
Residential occupancy	Blocks of flats ^{A)} Sheltered and extra care housing Residential care premises Student accommodation ^{A)} Dormitories (e.g. attached to educational establishments) ^{A)} Hostels ^{A)}
High rise occupancy	All residential buildings 18m or higher
<i>A) Any building of a height greater than 18 m is to be treated as a high-rise occupancy</i>	

On the table below we outlined the minimum system enhancement required by occupancy type. We also benchmark how an equivalent robustness and resilience to a category 1, 2, 3 or 4 BS9251 system can be achieved using Automist.

		Domestic Occupancy	Residential Occupancy	High Rise Occupancy
BS9251 Category		1	2 or 3	4
Automist system enhancements	Discharge Duration	30 mins	30 mins	60 mins
	System Resilience	1. Fault signals indicate an error: persistently warbling sound and red LED flashing	1. Fault signals indicate an error: persistently warbling sound and red LED flashing, and 2. Controller visual checks in line with alarm testing frequency, and/or 3. Remote monitoring	1. Fault signals indicate an error: persistently warbling sound and red LED flashing, and 2. Controller visual checks in line with alarm testing frequency, and/or 3. Remote monitoring
	Detection Resilience	1. Battery powered alarms permitted as monitored by system fault signals	1. Battery powered alarms permitted as monitored by system fault signals, and 2. Controller visual checks in line with alarm testing frequency (see page 101)	1. Battery powered alarms not permitted; mains powered alarms with battery backup only
	Power Robustness / Resilience	1. Independent circuit	1. Independent circuit, or 2. Independent circuit and dual power supply, or 3. Independent circuit and remote monitoring, or 4. Independent circuit and battery backup	1. Independent circuit and dual power supply, or 2. Independent circuit and dual power supply with remote monitoring, or 3. Independent circuit and battery backup 4. Independent circuit and battery backup with remote monitoring
	Water Robustness	1. At least 8 lpm, 1.5 bar mains supply, or 2. Install an 80 litre mains boost tank to provide supply	1. At least 8 lpm, 1.5 bar mains supply, or 2. Install at least a 200 litre mains boost tank to provide supply (see page 34 – a large tank size may be larger)	1. At least 8 lpm, 1.5 bar mains supply, and 2. Install at least a 500 litre mains boost tank (see page 41 – a large tank size may be larger)
	Spray head Placement Robustness	Preferred positions	1. Preferred positions, and 2. Head clearance visual checks in line with alarm testing frequency (see page 101) - Consider focusing checks with individuals identified in a Person-Centred Fire Risk Assessment (PCFRA) with greater propensity to obstruct the head	1. Preferred positions, and 2. Head clearance visual checks in line with alarm testing frequency (see page 101) - Consider focusing checks with individuals identified in a Person-Centred Fire Risk Assessment (PCFRA) with greater propensity to obstruct the head

Using Automist as a Compensatory Feature

There are occasions when Automist can be proposed as part of a fire strategy to compensate for, or overcome, circumstances where a building is unable to follow guidance issued in support of building regulations. If being used as a “compensatory measure”. This should be stated in the client’s Requirements Specification and whether any system enhancements are required as a result.

There are also occasions when Automist can be proposed as part of a fire strategy to mitigate risks in existing buildings, observed by a fire risk assessment, to meet the requirements of the Regulatory Reform (Fire Safety) Order and the Housing Act 2014, e.g.:

- a) an older building where the existing construction cannot achieve the recommended fire resistance appropriate to the use of the premises;
- b) a building that cannot meet the recommendations for fire appliance access;
- c) any building where there is doubt about adequacy of fire protection and safety provisions, or concerns over design of building in relation to fire safety, e.g. stay-put policy, single staircase, combustible materials of construction within the occupied spaces, etc.; and
- d) any circumstances in which Automist is provided as a compensatory feature for departures from other Standards or national guidance, e.g. BS 9991 permits certain forms of open plan dwelling provided the dwelling has fire suppression throughout or is fire engineered.

This DIOM does not intend to cover all design requirements and the potential changes to category and resilience of the system to cover all circumstances of use and risk.

In accordance with BS 8458 4a), 4b) and 4c), when Automist is proposed as a compensatory measure, the designer should consult the AHJs on the use and specification of the system; if necessary, supported by a fire safety strategy; and the resilience measures should be defined, appropriate and recorded.

In case of doubt, Plumis and/or a chartered fire engineer should be consulted regarding the most suitable specification of the system and a fire safety strategy should be drawn up to support the proposals for the specific case. See also BS 9991, BS 9999, BS 7974.

Higher fire risk and impact factors

The default design and settings of Automist and fire validation tests within BS 8458 are designed for typical domestic occupancy in mind. An enhancement to the system should be proposed by the designer or fire safety engineer if any of the following risks or impacts are present, or assumed possible, in the property, to mitigate the risk of the system being overcome by the fire load or the discharge duration being shorter than the time for fire rescue operations to start (and if the risk has not been addressed by other interventions):

- a) fire hazard (probability) is greater than that of a conventional domestic or residential occupancy, indicating a need for higher resilience;
- b) a fire load greater than that which would normally be found in a residential or domestic living room, kitchen, or bedroom, or if the fire hazard is greater than that of a conventional residential or domestic occupancy; Hoarders pose a significant fire risk due to the number of possessions, exit routes can become blocked, making safe evacuation more difficult. Fires can also spread much faster, especially where there are flammable items such as newspapers or cardboard.
IMPORTANT! Automist Smartscan is not designed for fire loads that exceed a BS 8458 fire setup, and therefore will likely have a limited benefit when protecting hoarders.
- c) extended time for firefighting operations to commence, e.g. high rise, complex or remotely located buildings, indicating a need for higher water robustness;

- d) older buildings with hidden voids and/or where passive fire protection and/or means of escape might not meet current standards, indicating a need for higher resilience;
- e) heritage buildings where preservation of the building needs to be maximised while minimising the potential for water damage, indicating the need for increased resilience;
- f) fire engineered design solutions, which may require several measures, including resilience and robustness;

Occupancy profile - vulnerable people risk factors

In cases where Automist is being considered and the individuals occupying the property have a higher-than-average likelihood of having a fire, or have poor reaction or realisation of the danger presented by fire (or a combination of both) the design may require enhancements in system resilience, or depending on the risk, a different solution altogether (such as a PPS).

The following factors are indicators of an occupant's higher risk from fire:

- a) higher likelihood of fire:
 - a. high fire risk habits, such as disposal of smoking materials or leaving cooking unattended;
- b) history of fire-setting behaviour;
 - a. history of previous fires or evidence of near misses, such as scorch marks on clothing or furniture; or
 - b. threats of arson;
- c) inability or willingness to escape:
 - a. impaired mobility affecting ability to escape;
 - b. impaired, due to cognitive ability to react to fire or warning devices;
 - c. impaired senses affecting ability to respond to alarm;
 - d. poor situational awareness; or
 - e. alcohol or drugs, increasing the likelihood of a fire and lowering reaction to alarm.

The activation of Automist can also be transmitted to a permanently staffed location, locally or remotely, in accordance with BS 8458 6.11.3.4, when specified in the Requirements Specification.

Improving Automist's performance and reliability

Additional measures to improve the performance and reliability of the system to address areas of higher risk should be considered and include but not be limited to any of the following:

- 1) increasing the system resilience; and/or
- 2) increasing the detection resilience; and/or
- 3) increasing the power robustness; and/or
- 4) increasing the water robustness; and/or
- 5) increasing the spray head placement robustness; and/or
- 6) increasing the spray head density or installing two Automist systems in parallel; and/or
- 7) Increasing the frequency of the maintenance.

System enhancements should be recorded on the Automist Design Specification (see page 17) and, once installed, in the commissioning certificate (see page 94).

This DIOM gives guidance on the types of risks and the performance enhancements which are possible, but whether these are satisfactory is the responsibility of the client (and/or their representatives) in consultation with all stakeholders and any relevant authority having jurisdiction (AHJs).

Resilience and Robustness

Improving the system's resilience (the ability of the system to return to a "ready to operate" state) can be achieved by increasing the frequency and nature of monitoring beyond the minimum annual maintenance check (see page 101). This is desirable when either the impact of the fire or the probability of fire are high.

Improving the system's robustness (the ability of the system to tolerate disruption) is required when the water, power supply or obstruction mitigation has poor reliability and/or the consequences have high impact.

The measures are listed are used, as default, in isolation or combination to increase the levels of robustness and/or resilience:

- a) System
 - 1) Fault signals indicate an error: persistently warbling sound and red LED flashing (see page 81)
 - 2) Visual inspections of the Automist controller at a rate, equal to, or greater than, the frequency of any alarm testing already in place (e.g. at least weekly in residential care). If there is no alarm testing in place a 'reasonably practicable' inspection rate should be chosen (see page 101).
 - 3) Remote fault monitoring using the Automist IoT controller which generate alerts of outages.

- b) Detection
 - 1) Battery powered alarms permitted as monitored by system fault signals (see page 81)
 - 2) Controller visual checks in line with alarm testing frequency (see page 101)
 - 3) Battery powered alarms not permitted; mains powered alarms with battery backup only
 - 4) Detection integrated into existing BS 5839-6:2019 + A1:2020 system, Grade D or above (see page 51)

- c) Sufficient water supply should be ascertained at a time of peak demand, so that there is sufficient pressure and flow available from the mains to allow the system to perform (see page 41). As the water supply for Automist is shared with the domestic or residential supply, the water must be capable of providing the minimum flow and pressure. If either is not sufficient it must be boosted to provide the minimum requirement by a mains boost and tank (see page 41), of at least:
 - 1) 80 litres (domestic)
 - 2) 200 litres (residential)
 - 3) 500 litres (high rise)

- d) In accordance with BS 8458 6.11.4 *'the electrical supply to the pumps should be installed to minimize the risk of electrical supply failure by having a separately fused connection taken after the meter and from the supply side of the consumer unit (see BS 7671), using approved fire-resistant cabling'*. Back-up power supply and automatic changeover functionality can be provided by:
 - 1) an emergency generator
 - 2) uninterruptible power supply (UPS)
 - 3) Dual supply from both the communal (landlord's supply) and dwelling supply (residential or high rise only)
 - 4) Remote monitoring can be connected to monitor power outages or activations

- e) Spray head placement

- 1) Preferred positions are locations where the likelihood of a spray head being obstructed are avoided (see page 34).
 - 2) Head clearance visual checks at a rate, equal to, or greater than, the frequency of any alarm testing already in place (e.g. at least weekly in residential care). If there is no alarm testing in place a 'reasonably practicable' inspection rate should be chosen (see page 101).
 - 3) Adding additional heads beyond the minimum requirement in this DIOM (see page 41) to ensure there is full visibility of hazards in a room prone to multiple tall obstructions.
 - 4) Installation of two system in parallel (see page 41).
- f) Maintenance frequency
- 1) The routine inspection rate of key components (controller fault signals and spray head clearance) should be equal to, or greater than, the frequency of any alarm testing already in place (e.g. at least weekly in residential care), and a maintenance programme for the system should be at least annually. The frequency can be increased depending on the risk. It is worth considering focusing inspection to individuals identified in a Person-Centred Fire Risk Assessment (PCFRA) with greater propensity to obstruct the head or tamper with the system.

DESIGN AND SPECIFICATION

Introduction

Automist must be designed by a competent and suitably trained Authorised Reseller Installer (ARI) Designer in accordance with this DIOM.

Fire Tests and Limits of Application

Automist was tested against the fire performance in BS8458 at Warrington fire. Warrington fire operates in accordance with BS EN ISO/IEC 17025:2017 as required by BS 8458:2015. For more details see:

- Automist Smartscan Hydra Exova Warrington test report - BS 8458: 2015: Annex B, Method for Measuring the Capability of a Watermist System to Control a Fire.pdf
- Automist Smartscan BSi Verification Certificate for BS 8458 performance requirements - BSi Verification Certificate.pdf

The system complies with Clause 6.1 (a) & (b) for domestic and residential premises at a maximum room size of 80m² and a ceiling height of 3.5m. Clause c) is deemed not applicable because Automist is an electronic nozzle and does not rely on a mechanical glass bulb. Automist's electronic activation ensures that only one of the (up to six) spray head in the system activates, the one with the best visibility of the fire. Therefore, removing the concern that another spray head in an adjacent room (the third nozzle criterium) may activate mechanically and share the water allocated for the room of fire origin.

An increased ceiling height can be considered if there is no fire loading above 2m. However, this requires a written justification from a fire engineer because it was observed on third party fire testing at a ceiling height of 6.1m that there was no significant difference in time of detector activation (+/- 5 seconds) but a faster heat release rate growth was observed at the higher ceiling than the lower ceiling for the same fire load.

For high ceilings beam or aspirating detectors should also be considered to shorten the activation time due to their greater sensitivity over a larger area than point detection. This situation may also trigger additional robustness and resilience measures (see page 22).

Extent of Automist protection

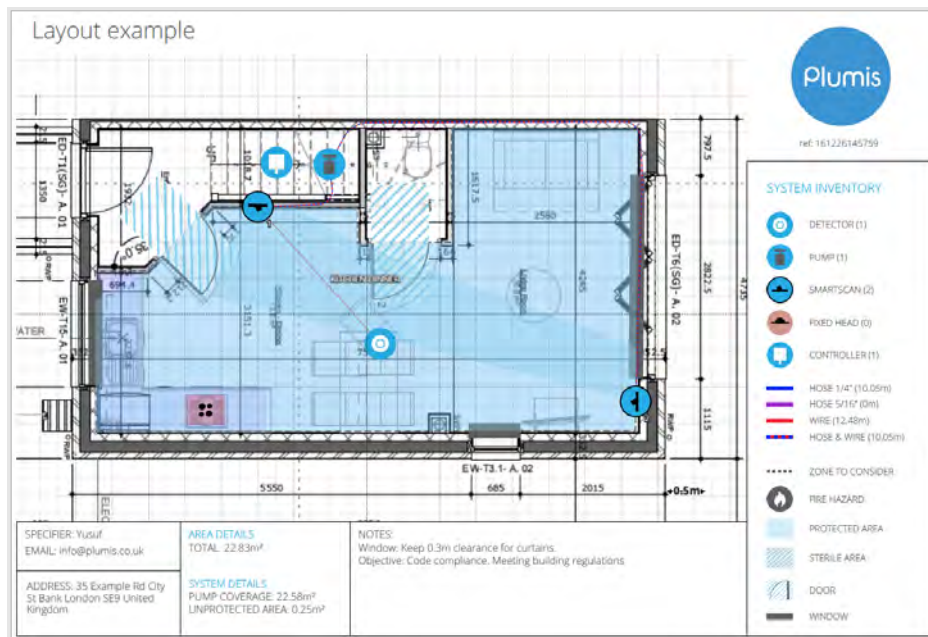

Figure 4: Automist Layout drawing

Automist layout design must be created using the online ARI layout tool to show sufficient coverage to all the areas identified in the Design Specification (see page 17). The overall objective of a layout plan is to ensure the coverage pattern covers all the square footage within the property. If in doubt, it is always advisable to add another head to your scheme. The allowable shadow area (unprotected space) is:

- 1.2 m² per nozzle

Automist Smartscan Hydra supports up to 6 spray heads per system (pump and controller).

In accordance with BS 8458 6.4, the extent of Automist coverage should include all parts of the dwelling, except for the following areas, which may be excluded unless required by a fire strategy or risk assessment:

- 'bathrooms fitted with a door and with a floor area of less than 5 m²;
- cupboards and pantries fitted with doors and with a floor area of less than 2 m², and rooms in which the smallest dimension does not exceed 1 m, where the walls and ceilings are covered with non-combustible or limited-combustible materials;
- non-communicating, attached buildings such as garages, boiler houses, etc.;

"Non-communicating" means separated from the protected premises by not less than 30 min fire resisting construction in accordance with the relevant part of BS 476 or the equivalent European Standard, for example:

- BS 476-21/BS EN 1365-1 for load bearing walls;
- BS 476-22/BS EN 1364-1 for non-load-bearing walls and partitions;
- BS 476-21/BS EN 1365-2 for floors;
- BS 476-23/BS EN 13381-1 for suspended ceilings;
- ad hoc BS 476-20/BS EN 1366-3 for penetrations of walls and floors by services.

The parts of the BS 476 fire resistance test standards are to be read in conjunction with BS 476-20. The European fire resistance test standards are to be read in conjunction with BS EN 1363-1.

There might occasionally be a need to refer to other fire resistance test standards, depending on the design of the building. Certain authorities might require 60 min fire-resisting construction.

- d) crawl spaces;
- e) uninhabited loft/roof voids;
- f) ceiling voids;
- g) external balconies permanently open to the outside.'

A fire strategy or risk assessment can demonstrate that extensive spread of fire or smoke, particularly between rooms and compartments, is likely to take place and therefore that the fire risk in the area is such that Automist coverage is necessary.

The Automist installation should be designed to facilitate easy maintenance. Parts requiring service or access (e.g. the filter and controller) should be located in an accessible location.

When the system is used as an elective fire safety upgrade for enhancing an otherwise code compliant dwelling, certain design guidelines can be relaxed depending on the objective (e.g. covering only the hob area when a client wants to use the system to reduce the risk of cooking fires in an otherwise code compliant property) but this must be documented by the Authorised Reseller Installer (ARI) Designer and verified with the client.

Automist Design Guidelines

A single Automist Smartscan Hydra spray head has a maximum 6m range in front and 4m range either side along the wall depending on the spray heads location. The spray pattern acknowledges it is easier for us to address fires in front of the spray head as opposed to alongside it.

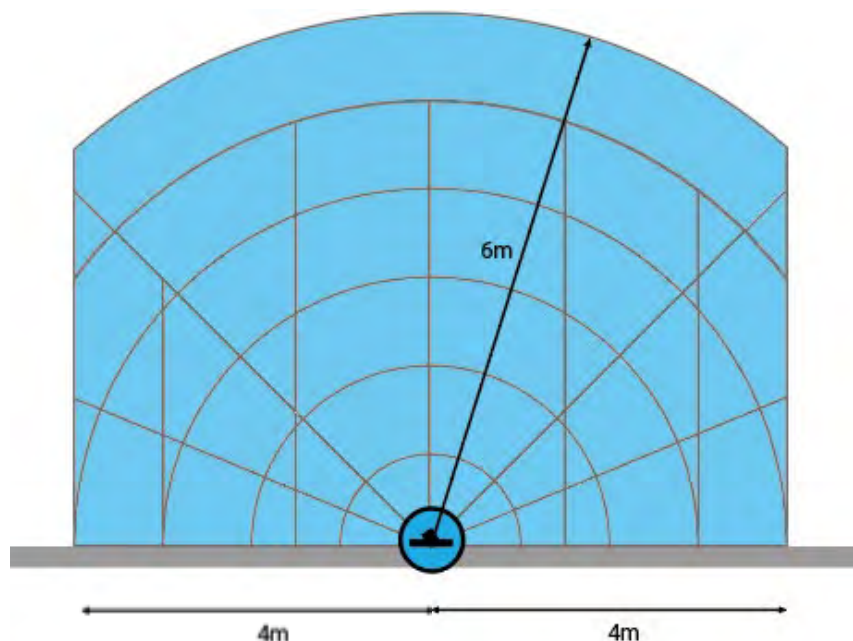

Figure 5: Automist Smartscan Hydra Spray Pattern

The spray head must therefore have approximate line of sight of any possible fire hazards within this range, and be positioned at least:

- 1.5m away from any hob

- 1.5m away from any oven (if in direct line of sight)
- 3m away from any log burners or small fireplaces

Visibility extends radially from each mist head and ends wherever there is an obstruction. If an obstruction is fixed and equal or more than 0.9 m high (standard worktop height), it must be regarded as blocking the line of sight from any spray head positioned within 3m and reflected in the layout drawing. For example, bookshelves, wardrobes, large fridges, or vertical radiator covers. Obstructions higher than 0.9 m and wider than 0.3m must be regarded as blocking the line of sight at any distance. This does not relate to a householder deciding to disable the suppression system; full obstruction of the spray head or the creation of de facto room partitions with bookcases are akin to wilfully removing fire doors, decorating over sprinkler heads, or removing detectors and are beyond the scope of this recommendation.

Spray head Location

The Automist spray head

The spray head is engraved with KEEP CLEAR and DO NOT COVER. Authorised installers are also trained to instruct the occupant how the system works and give simple guidelines of use. Plumis also leave a tag on the spray head upon completion of installation and encourage the user to visit our website so they can learn more about its operation and register online.

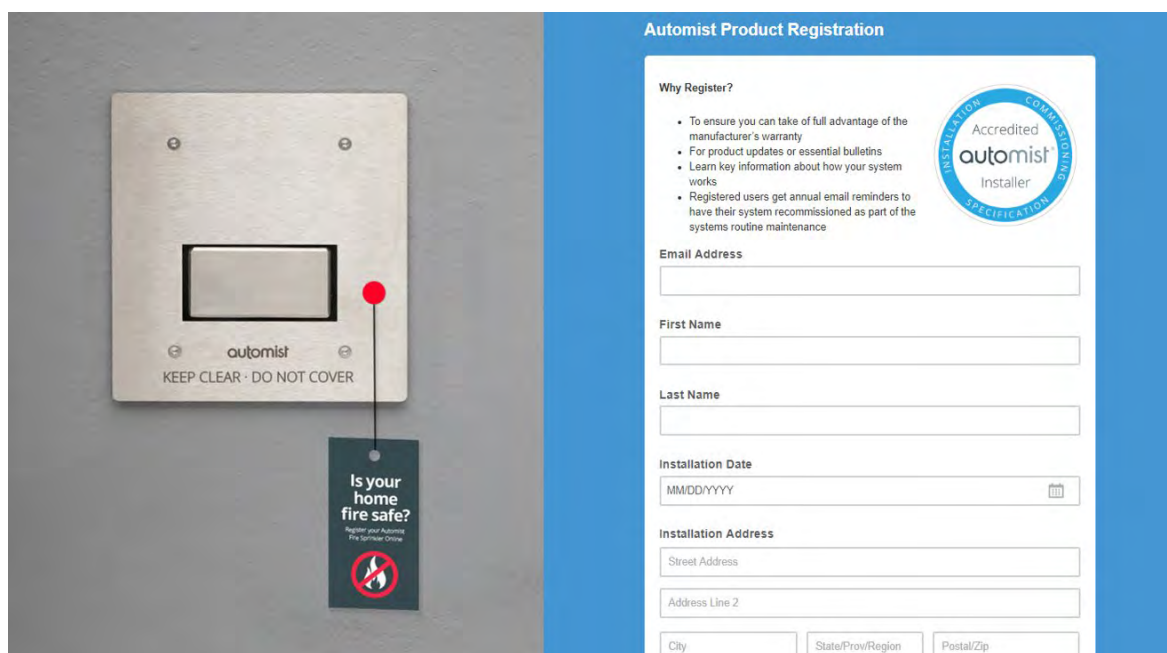

Figure 6: Installed Automist spray head (left) Product registration page (right)

The Automist Smartscan Hydra Head is designed to be affixed into a rectangular hole (89+/-2mm wide x 117mm high) that is at least 57mm deep when using the spray head “foldable bracket” (part number SK11) provided on a vertical wall.

If you are installing Smartscan Hydra using a Back box, the hole dimensions are as following: 94mm wide x 119mm high and 60mm deep.

IMPORTANT! The Automist Smartscan Hydra head must be located where the spray pattern will not be obstructed and 1500mm horizontal clearance provided 180 degrees around the spray head.

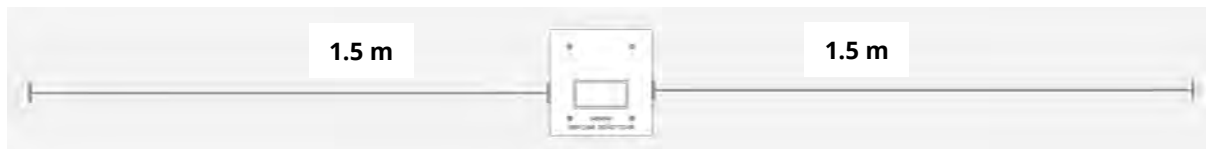

Figure 7: Keep 1.5m horizontal clearance around the spray head

The spray head height is different depending on where it is placed:

a) Kitchen

The kitchen is the one room in a standard dwelling with a fixed layout/furniture. The standard spray head height is placed at a lower height in this room for better targeting of the significant fire risks under countertop; white goods and the hob/cooker in a room assuming a standard worktops height of 90cm high. In kitchens designed for wheelchair users, white goods and ovens, the main fire risks, do not have their heights altered and therefore these rules also apply to these types of kitchens.

a. Not above a worktop

Ideally the spray head(s) should be located opposite the worktop (see page 36). For installation in the kitchen area, the spray head must be installed at a height of 1100 - 1450mm where there are no islands and 1200-1450mm where there are islands. Locate the head at the lowest possible height within that range.

b. Above a worktop

If there is no wall space available opposite the worktop, for example in a galley kitchen, mount the spray head above the worktop. The head must be located at least 100mm from the bottom of the upper cupboard (so the spray pattern is not affected by the cupboard above), and as high as possible above a worktop up to 400mm (to help is clear any potential worktop objects).

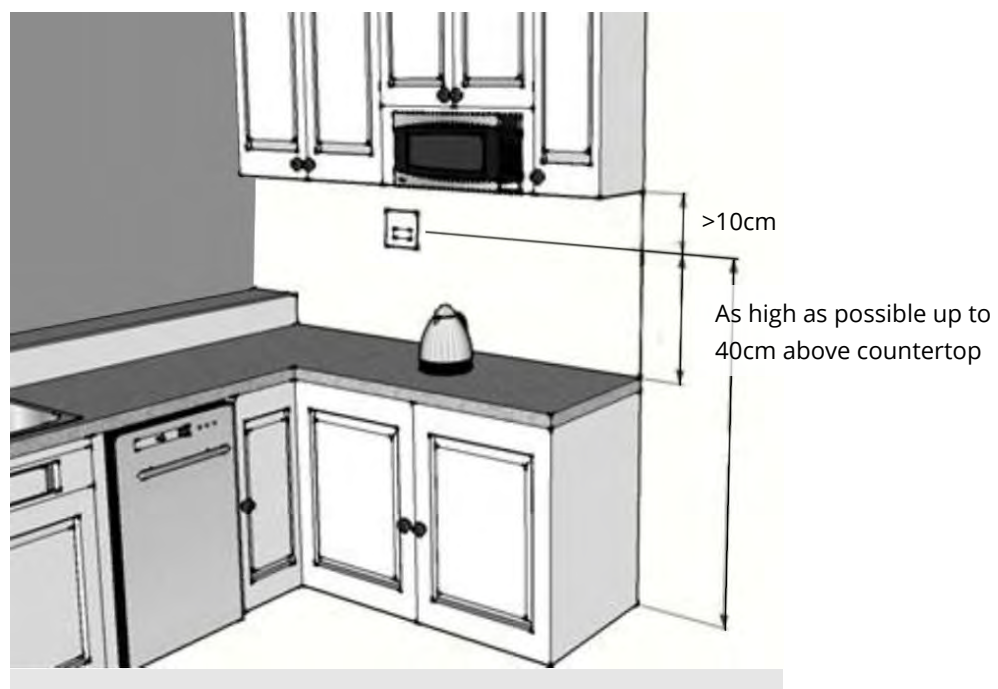

Figure 8: Automist Smartscan Hydra head positioned above kitchen worktop

b) Everywhere else

The spray head must be installed at a height of 1200 - 1450mm from the finished floor level in non-kitchen area.

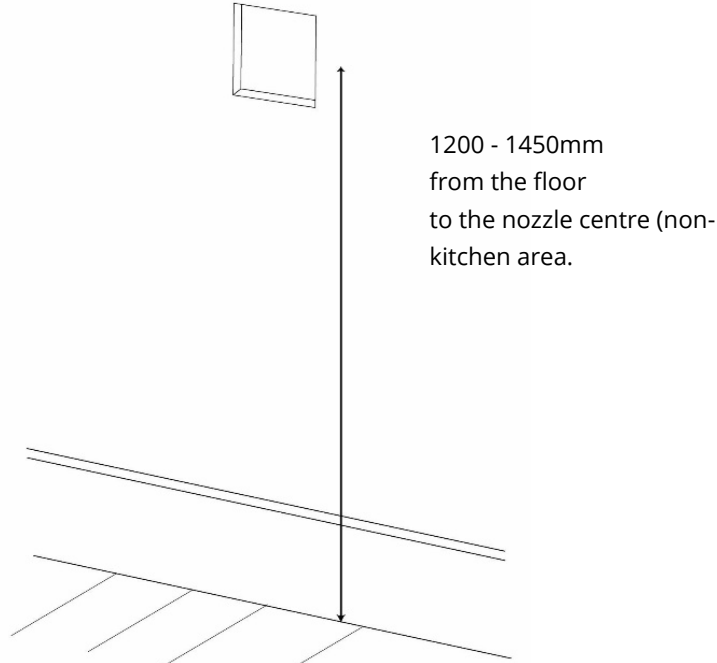

Figure 9: Automist Smartscan Hydra spray head mounting hole (non-kitchen area)

The locations of the spray head are summarised in the table below:

	Kitchen			Everywhere else
Assumption	Less non fixed furniture which can obstruct the heads (fridge only)			More large movable furniture (cabinets, wardrobes, fireplace ledge)
Objective	A lower height as possible to tackle fire risks under the worksurface			Ability to clear the vast majority of furniture (1.30m) but be as low as possible as performance is best when more watermist is deployed lower down
Location	Over worktop	If no island	Not over worktop	
Height	300 above surface and 100 below cupboard	1100 - 1450 (low as possible)	1200 - 1450 (low as possible)	1200 - 1450 mm (low as possible)

Table 1: Spray head heights depending on room

IMPORTANT! Automist should not be used in areas with a large (greater than 2 sqm) highly polished metal surface without a glass coating, such as a commercial kitchen, as the accuracy of the fire detection could be reduced. A conventional mirror is covered by a layer of glass, so does not attenuate the infra-red signature, unlike a highly polished metal surface.

Obstructions

In accordance with BS 8458 6.3, nozzles should be positioned to avoid obstructions. An obstruction can impact the ability of an active fire suppression system to suppress a fire and its objective to cap the fires growth (limit the production of heat and toxic gas). The obstruction risk for the Automist system differs from traditional ceiling mounted systems. The following must be considered (but not limited to):

	Traditional ceiling mounted suppression	Automist Smartscan
Spray head	Ceiling mounted	Wall mounted
Obstruction Plane	Horizontal	Vertical
Examples of obstruction to either detection or suppression	Concealed fires (e.g. under worktops and cupboards, fire under a table or sofa), painted sprinkler head, light fixtures, ceiling fans, beams girders under joints, high wardrobes under the nozzle.	Large wall mounted furniture (e.g. a fridge, a bookcase, wall cupboard or cabinet, wardrobe) too close (horizontally) to the spray head.
Mitigation method	Locating spray heads with sufficient clearance from beams, racking, girders, etc.	Locating spray heads in "Preferred Positions" (see page 35) and automatic design software checks.

All fire safety products require education of, and co-operation with, the owner of the dwelling to ensure they will work. Be it, preventing compartmentation from being compromised by tradesperson, fire doors from being propped open, smoke alarm batteries from being removed, or stopping people from placing things in the path of fire curtains.

The spray head has a unique perspective of the room.



Figure 10: The 180 degree panorama view of the room from an Automist spray head

This height of the spray head allows for a clear view over most of the furniture in the home.



Figure 11: Diagram of the spray head height in relation to typical living room furniture

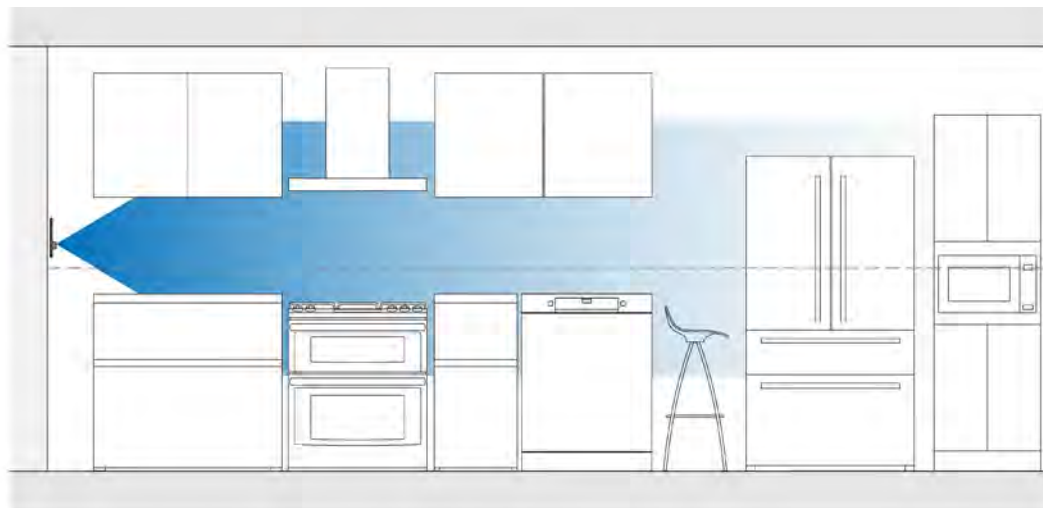

Figure 12: Diagram of the spray head height in relation to typical kitchen furniture



Figure 13: Drawing of the spray head height in relation to typical bedroom furniture



Figure 14: Drawing of the spray head height in relation to typical living room furniture

As you can see from the diagrams, the biggest potential obstruction to Automist is large wall mounted furniture over 1350mm tall (see dashed lines above).

Fixed obstructions that are built within the fabric of the building for example an island unit in a kitchen are classed as obstructions if over 0.9m. These obstructions should be taken into consideration when choosing the mounting height of the sprayheads.

How Automist is affected by obstructions

When detecting the heat source to target with watermist, the infrared sensor on the spray head searches for the point in the room where the temperature is increasing the fastest or a peak temperature beyond a threshold. The spray head targets the hottest visible area, even if the view is partially obstructed because all the heat accumulates on the ceiling emanating from the centre of the fire.

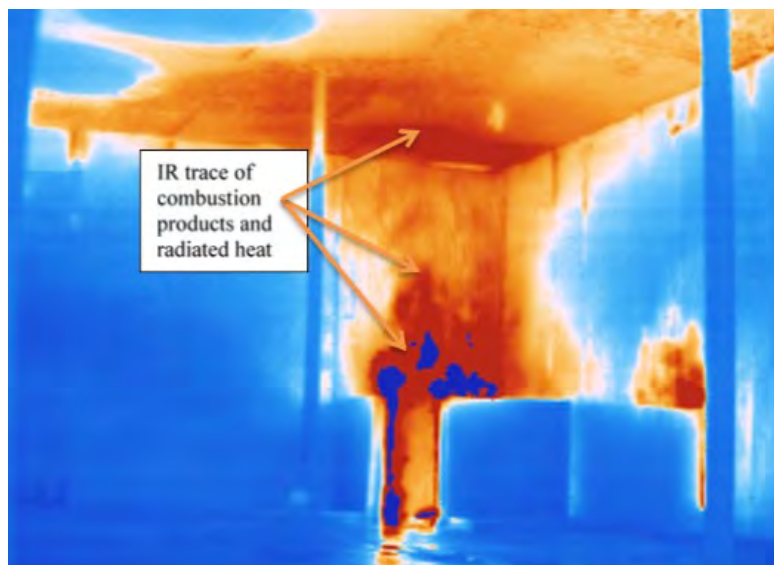

Figure 15: Interpretation of how the IR sensor views the fire

Watermist uses a different principle of firefighting to traditional sprinklers, which suppress fires by wetting surfaces and directly cooling the flames with large water drops. Watermist uses fine droplets, which evaporate at the base of the fire, to extract heat and displace the oxygen. This results in fire control, suppression, or extinguishment depending on the fire type. Our spray heads are wall-mounted to avoid ineffective evaporation in the hot layer in the ceiling and the upward flow of hot combustion products. i.e. smoke. Automist leverages the natural buoyancy the hot fire effluents creates and seeks to ensure watermist is entrained into the fire plume.

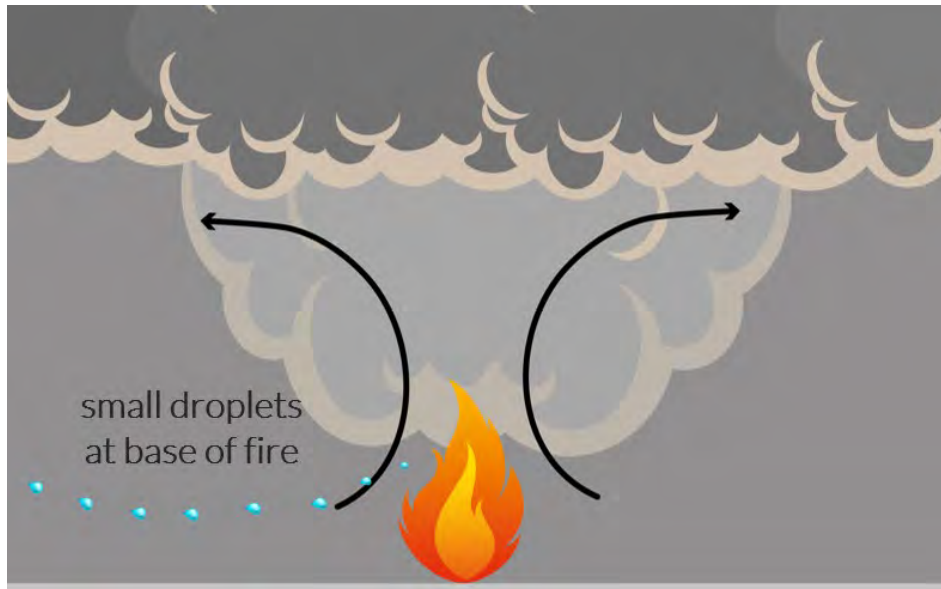

Figure 16: Watermist droplets being entrained into the fire's turbulence

Preferred Positions

When installed in a domestic or residential dwelling the spray head must be positioned in locations that minimise the likelihood of the nozzle being obstructed. The Automist [online layout software](#) automates this process by reducing the theoretical coverage in the layout drawing when the heads are not located in preferred positions, locations where our historical data shows they are most likely to perform.

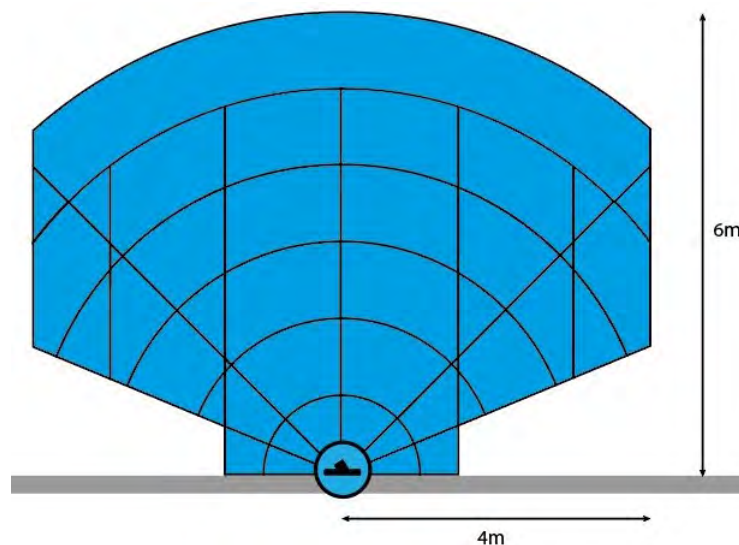

Figure 17: Automist Smartscan Hydra Spray Pattern (default in layout tool), as we assume the homeowner could introduce an obstruction alongside the head

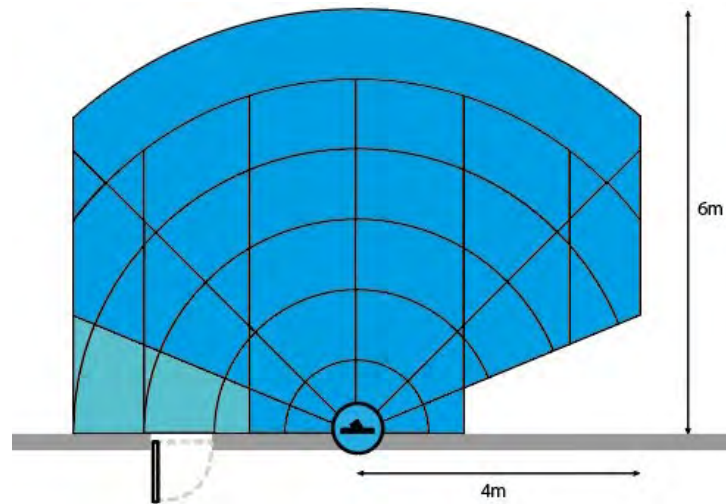

Figure 18: Automist Smartscan Hydra Spray Pattern (when in preferred position in layout tool)
e.g. Using the proximity to the door to increase the theoretical spray pattern

It is a responsibility of the Plumis Authorised Reseller Installer (ARI) Designer, working in conjunction with the Installer, to locate the spray head in positions considerate of the principals below (where 1 supersedes 2, and 2 supersedes 3):

1. Select a position where the likelihood of placing something directly in front of the spray head is reduced (see page 35).
Use the proximity to a feature in the room where people are less likely to put something against the wall (e.g. a light switch)
2. Select a position with a direct and unobstructed line of sight to the fire risks (see secondary objective (see page 36)
Ensure most of the potential fire risks are in front of the spray head (e.g. the kitchen hob)
3. Select a position where the impact of placing something alongside the spray head is reduced (see page 37)
Use shorter walls and in proximity to features unlikely to rest something against (e.g. windows and doors)

Annual maintenance (see page 101) includes a verification that the system is not being obstructed inadvertently. If any head is found to be obstructed, the ARI must issue the customer with a non-compliance notice, offer them a solution (relocating or adding an additional head) and inform Plumis. This feedback helps Plumis ensure the preferred positions principles are in line with how people use their homes, and improve recommendations for the future.

As per the Authorised Reseller Installer (ARI) contract obligation the ARI must:

- *Submit complete and accurate technical documentation to Plumis including but not limited to, design layouts, completed commissioning forms and declaration of any deviations from this DIOM*
- *Acknowledge and accepts that it shall remain fully responsible for all system designs and any deviations from the Company's installation guidelines*

Primary Objective

Our primary objective is to select a position where the placement of an object directly in front of the spray head is avoided.

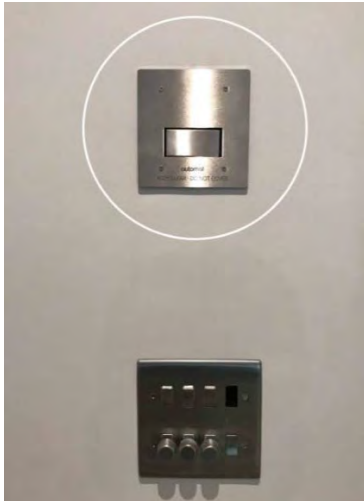

Figure 19: Preferred position within 30cm of a light switch

(N.b. Take extra care to consider the location of wiring for the switch)



Figure 20: Preferred position built into a cupboard or joinery

(N.b. If this head is not covered by an adjacent head, the head and hose must be housed in a fireproof material)



Figure 21: Preferred position on a staircase

(N.b. If this head is not covered by an adjacent head, the head and hose must be fire protected)



Figure 22: Preferred position above a sink



Figure 23: Preferred position in front of a nib (at least 0.3m deep and 0.25 - 0.6m wide)



Figure 24: Above a radiator

Secondary Objective

The secondary objective is to ensure the spray pattern covers all the floorspace within the protected area (see extent of coverage in the DIOM).

In a kitchen, the location of the spray heads should be selected on the wall opposite the likely fire sources:

- All worktops (as whitegoods are often located underneath)
- Oven / hob
- Fridge

The risk of obstruction is lower in rooms with fixed layouts/furniture like kitchens. Typically, the only large movable item of furniture in the kitchen is the fridge. If all worktops, the oven, and the hob are in the 45

degrees in front of the spray head, only obstructing the spray head directly will obscure the view of the main fire risks. This configuration reduces the potential impact of placing something alongside the spray head.

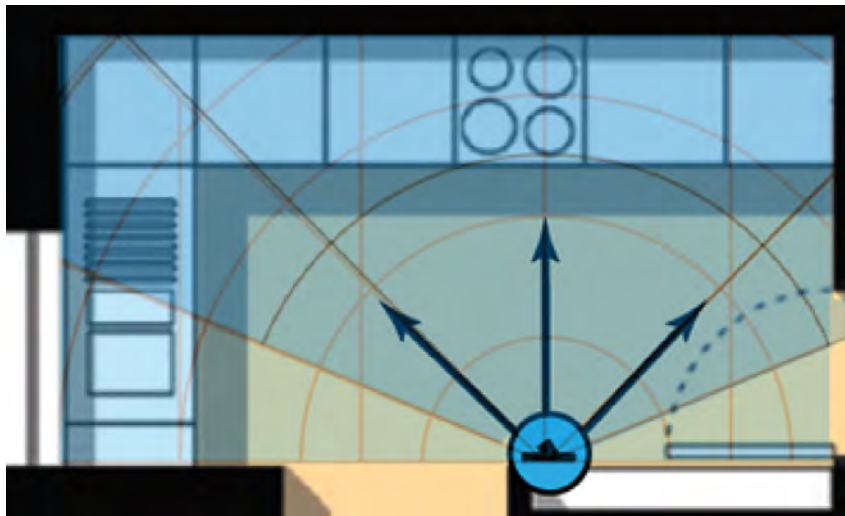

Figure 25: Example of a good spray head location with good line of site to the kitchen fire risks

In an open plan living room, the staircase is often an ideal location opposite the likely fire sources:

- Wall-mounted TV
- Sofa
- Fireplace

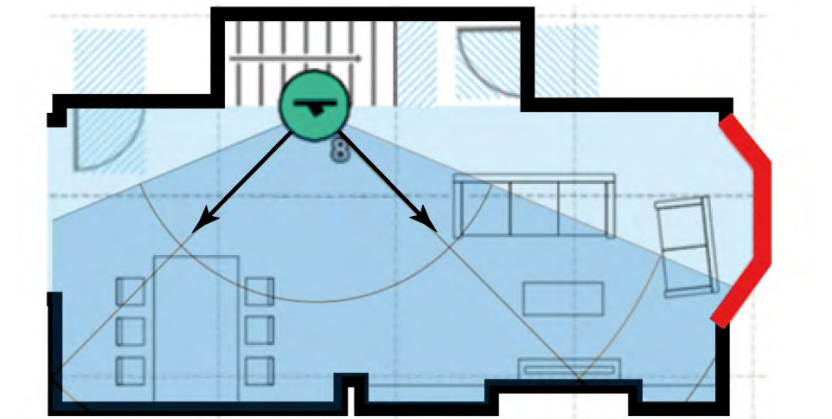

Figure 26: Example of a good spray head location with good line of site to the living room fire risks

Tertiary Objective

Our tertiary objective is to select a position where the likelihood of placing something alongside the spray head is reduced.



Figure 27: Keep 1.5m horizontal clearance around the spray head

This risk is increased the longer the wall is, so shorter walls are preferred. In a rectangular room it is preferable to spray with the length of the room (see *Figure 28*), as opposed to across the length of the room (**Error! Reference source not found.**) assuming this does not conflict with a primary or secondary objective. As you can see (below) an obstruction alongside the head, removes more coverage for the later.

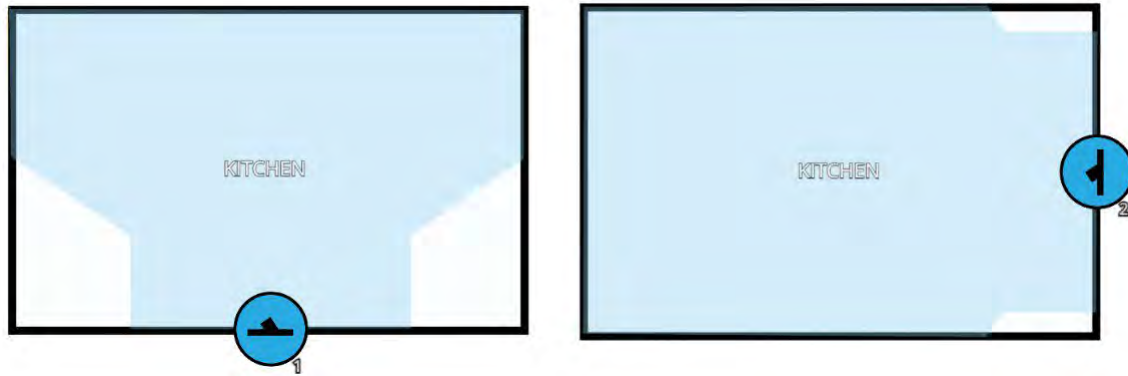

Figure 28: Spraying with the length of the room and across the length room

We can achieve this by using the spray head's proximity to a known feature, such as a window or a footprint door. This is because it is unlikely that people will put 'tall furniture' in front of a door or window. In doing so, we must ensure clearance is provided for any curtains, appropriate distance from the door hinge (0.8-1.5m) so the head is not located behind the door and is considerate of the direction of swing. Our working assumption is that the door will normally be propped open or closed. The spray head should ideally be on the side closest to the short wall.

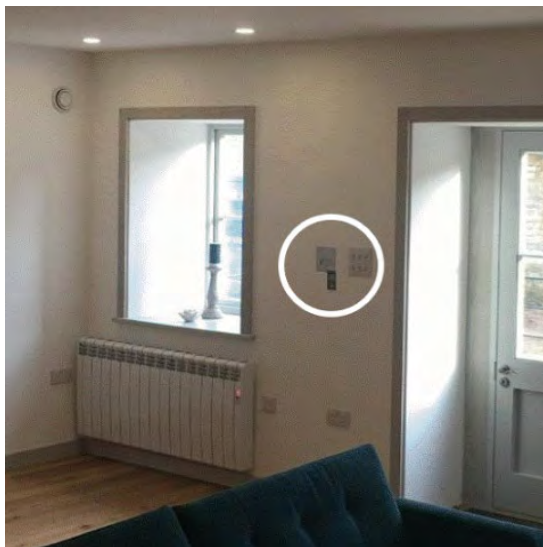

Figure 29: Preferred position alongside a window

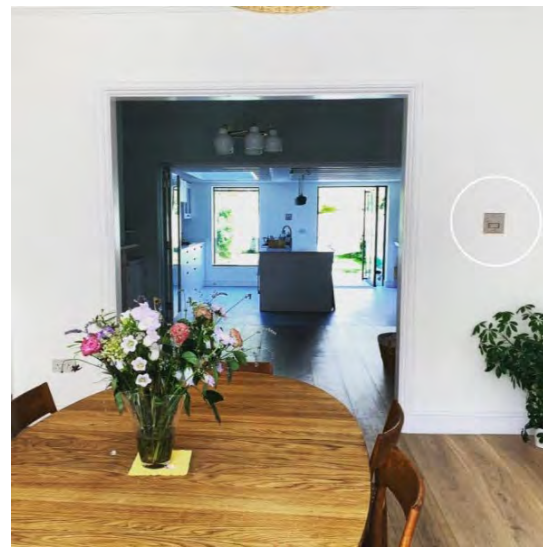

Figure 30: Preferred position alongside a door

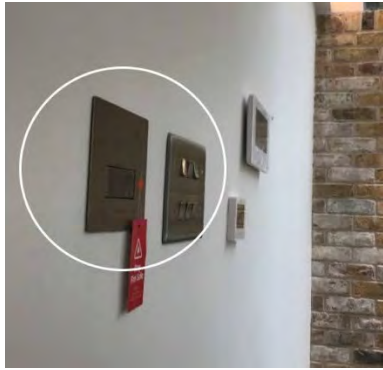

Figure 31: Preferred position alongside a light switch



Figure 32: Preferred position alongside a recessed shelf



Figure 33: Preferred position behind a sink

On longer walls and hallways, two spray heads (less than 4m apart) can be used to cover each other. Each spray head accommodates for a potential obstruction to the next one.

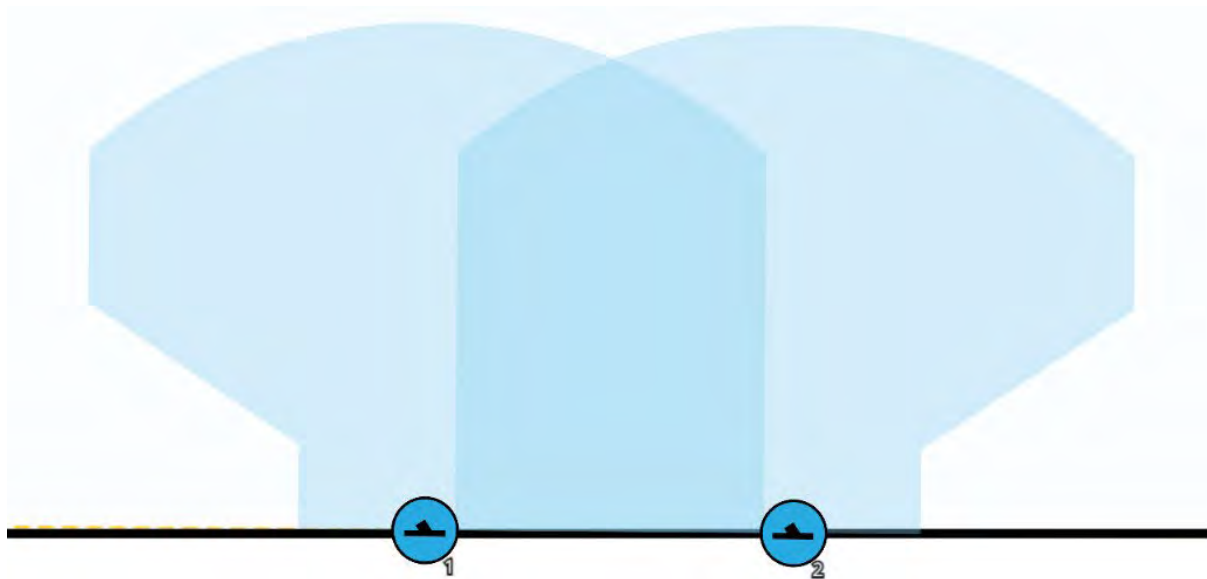

Figure 34: Utilising one spray head proximity to another

Spray heads must not be positioned close to corners. If head is too close to a corner (<0.55m) it can be obstructed by movable furniture on the adjacent wall.



Figure 35: Preferred position >0.55m from adjacent wall

IMPORTANT! Authorised Reseller Installers (Designer and Commissioners) can deviate from the layout plan if they can justify the principles are being satisfied but should update the drawing so a true representation of what was installed is captured with the rationale.

Hydraulic Calculations

Automist is a pre-engineered system with a maximum total hose length of 60m. All fire tests were performed with the worst-case scenario; 60m total hose lengths with 20m of 1/4" and 40m of 5/16". This causes the maximum acceptable delay in water discharge of, 21 seconds, and pressure loss for the system's water flow.

To determine the pressure losses and flows on the hoses specified by Plumis, measurements were carried out, given the lack of accurate data available for internal pipe surface roughness the hoses used in the Hazen-Williams and Darcy-Weisbach methods. The following key parameters have been measured for the Automist hoses through experimentation:

Parameter	1/4" hose	5/16" hose	Spray Head
Pressure loss (bar/m)	0.2165	0.0866	
Time delay (s/m)	0.25	0.40	
Pressure loss (bar)			3.5
K factor			0.62

Maximum high pressure hose length when:

- a) Both 5/16" and 1/4" hoses are used

Max. 1/4" hose length (m)	Max. 5/16" hose length (m)	Total hose length (m)
20	40	60

- b) Only 5/16" hose is used

Max. 1/4" hose length (m)	Max. 5/16" hose length (m)	Total hose length (m)
0	50	50

Below are the hydraulic calculations for the most unfavourable spray head configurations:

1/4" hose length (m)	5/16" hose length (m)	Total hose length (m)	Pressure loss (bar)	Time delay (s)	Flow Rate (l/min)	Pressure at pump (bar)	Pressure at nozzle (bar)
20	40	60	11.29	21	6.02	105.67	94.38
0	50	50	7.8	20	6.07	103.68	95.85

Discharge performance and duration

The electronic activation ensures only one watermist nozzle activates with not less than the pressure and flow given by the pass criteria determined by the BS8458 fire test in Annex C. The system is designed to run at 6 lpm, 80-110 bar pressure. The minimum and default runtime is 30 minutes.

IMPORTANT! 30 mins or longer (60 mins for cat 4 sprinkler equivalent) is available on request. An unlimited runtime is possible when Automist is connected to the main water supply and not limited by a tank.

Increasing the visibility of spray heads

It is always possible to increase the robustness of the spray head placement from obstructions by adding additional heads. This does not increase the discharge density as only one spray head, per system, will

activate (electronically controlled). In rooms where there is an increased likelihood of obstruction adding additional heads, over and above the minimum requirement, is an easy way to reduce the risk. A Person-Centred Fire Risk Assessment (PCFRA) can be used to identify any attributes of individuals with greater propensity to obstruct the head or tamper with the system.

Installing two Automist systems in parallel for increased density or robustness

It is possible to increase the resilience of the system and double the watermist output by installing two systems in parallel. This can be achieved by protecting the same space with two heads from different pumps. Care must be taken to consider double the water supply (see page 41) for this configuration as both systems may run at the same time depending on the fire.

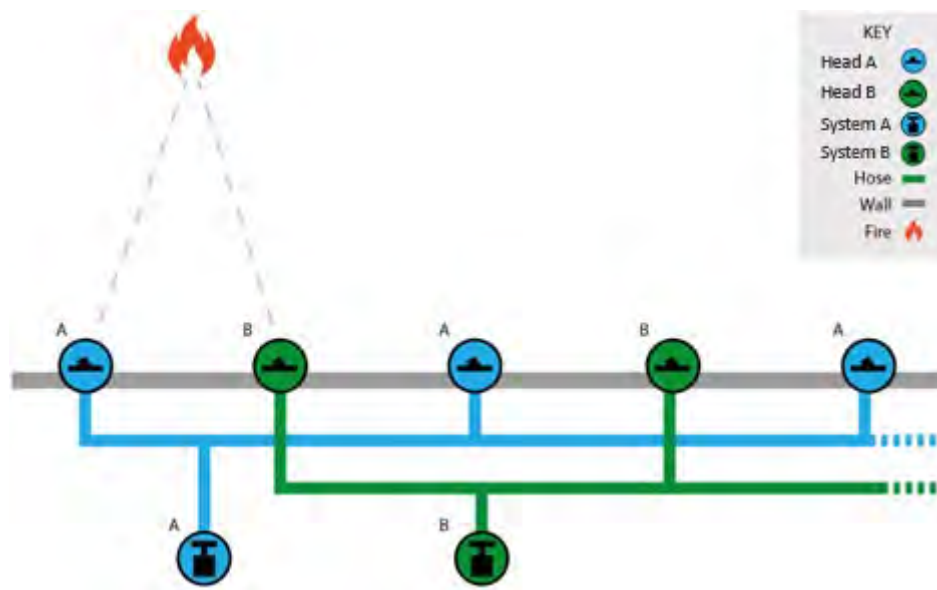

Figure 36: Installing two Automist systems in parallel

Water Supplies

A suitable water supply should be identified at an early stage to avoid unnecessary work at a later stage. The minimum mains dynamic pressure and flow should be ascertained at a time of peak demand at the earliest opportunity to ensure that there will be sufficient pressure and flow available to allow the system to perform as designed. Where there is concern about a mains water supply, a data logger may be used to establish a record of the standing pressure.

It is preferable to connect Automist to the mains water supply connection that serves both the watermist system, and the domestic or residential occupancy supply, over a stored water supply (dedicated tank), as it is more robust. This is because a mains supply is in constant occupant use and therefore if a fault develops, it is more likely to be addressed.

Typically, the kitchen sink cold tap would be supplied from the incoming mains water supply or straight from a cold-water storage tank in the loft and that should have the highest flow and pressure.

Automist must be connected to a reliable water supply, which delivers 8 litres per minute (lpm) flow at a minimum of 1.5 bar (150kPa) and a maximum of 16 bar (1.6 MPa) static pressure at the point of connection. The pump only requires only 6 lpm and 1 bar pressure, so a safety margin is embedded in this requirement. This is a deviation from clause 6.8.4.2 b) in BS 8458:2015 which recommends an additional 25

litres per minute for domestic occupancies which is a relevant rationale only for traditional mechanical water suppression systems which consume significant water flow as a proportion to total demand.

The minimum guaranteed UK Supply by the Office of Water Services (OFWAT) is 9 lpm, and the typical flow between 10 - 25 lpm. As Automist does not require more water than expected by a typically household appliance, and therefore, you are not required to inform the water undertaker.

For a single domestic dwelling with a low flow between 8- 12 lpm repeat the measurement above with either the bath tap fully open or the power shower on. Verify the supply for Automist can deliver over 6 lpm whilst this is occurring, this exercise is to ensure adequate flow is available during peak demand.

Where the mains water supply serves more than one dwelling, the mains should be capable of providing the flow and pressure at the point of connection for each system in accordance with the recommendations above of simultaneous peak demand from all the dwellings it serves.

If the mains pressure and flow is insufficient the water main can be boosted using a 'mains boost system' with a tank. An outside pipe diameter of less than 28mm is a good indicator that a mains boost system may be required. Mains boosting systems are designed to improve flow rates to all direct on mains appliances in the home. The objective is to improve the overall resilience of the water supply to the residence rather than just the supply for Automist only.

IMPORTANT: If a booster system is used to provide enough water pressure and flow to the property and Automist, this should be supplied by an independent circuit, as Automist's. This is to make it immune to a circuit breaker tripping in case of an electrical fire, cutting supply to the booster pump.

The mains boost tank size should be as follows, if required:

Category of system	Tank size
Domestic	At least 80 litres = 60 litres (10 mins supply at 6lpm) + 20 litres
Residential	At least 200 litres = 180 litres (30 mins supply at 6lpm) + 20 litres
High Rise building	At least 500 litres = 360 litres (60 mins supply at 6lpm) + 140 litres

The domestic cold-water tank should be capable of providing the building's peak demand for the required duration of Automist's run time, and Automist's maximum demand. If the building peak demand is larger than specified above a suitable large tank should be included. It is worth noting that the rate of automatic infill is considered in determining these minimum tank sizes.

Backflow Prevention

The product is also supplied with a WRAS approved single check valve assembly (suitable for backflow prevention up to Fluid Category 2), intended for installation at the inlet. Maximum working pressure: 10.0 Bar. Cold water use only.

Components

BS 8458 states in its introduction that 'the testing and approval of watermist system components for residential and domestic applications is a developing area'. As per FM 5560:

'Due to the current state of water mist system technology, a comprehensive absolute standard for the testing of water mist components is not possible. Since each water mist system is unique in its operation and design, the component testing of the water mist system shall be performed on a case-by-case basis.'

Automist components are not yet approved through third party certification. This is currently being actively pursued with Underwriter Laboratories (UL) in the US through a custom full system certification program for an electronically controlled water mist nozzle system. As Automist nozzles are outside the scope of BS 8663 and of BS EN 17450 and there is no certification available in the UK for this type of system. As soon as completed, all supporting evidence will be made available publicly. In the meantime, Plumis has carried out in-house and third-party testing of its nozzle to verify component durability and reliability, following the protocols in UL 2167 "Water Mist Nozzles for Fire Protection Service" and BS 8663-1:2019:

- General Construction / Product Assembly / Technical Literature / Dimensioning and pressure rating
- Strainer and Filter
- General Performance / K-factor
- Watermist Nozzle Requirements
- Hydrostatic Strength
- Stress Corrosion / Sulphur Dioxide Corrosion / Salt Mist Corrosion / Moist Air exposure
- Exposure Tests on Nozzles Incorporating Polymeric Gaskets: Tests to be carried out on O-rings used on assembled system (pivot and nozzle)
- Water Flow Test
- Water Droplet Size and Velocity: Positions customised for the horizontally oriented, 65° vertical spray fan, so that nozzle changes can be shown to provide equivalent spray characteristics.
- Hydrostatic Strength
- Vibration
- Rough Usage Test
- Impact Test
- Clogging Test

Additional relevant testing for an electronic nozzle has also been carried out, beyond the scope of BS 8663-1. For example, spray head swivel durability tests have been completed on Smartscan hardware to verify how many scans the spray head would perform before failure. Hydra completed up to 70,000 cycles, well over the expected lifetime requirement and the 6,000 cycles demanded for certification purposes.

Further details on the component testing are available on the Plumis due diligence website.

Watermist nozzle (Automist spray head)

Automist's watermist nozzles are provided assembled with the spray head and fitted with an inlet filter during installation to prevent blockage during service. The water filter is qualified to maximum 6 bar. Therefore, the PRV (pre-set to 3 bar, maximum 16 bar input) must be installed upstream of water filter as shown in Figure 2). Filters selected are made of corrosion-resistant materials and designed such that spheres with a diameter of more than 0.8 times the minimum nozzle waterway dimension cannot pass through.

Any spray head removed from the system should be returned to the manufacturer for analysis or factory refurbishment. Replacement nozzles and/or filters, should be fitted and only new or refurbished equipment should be used.

Spray head Specification:

Weight	1.3 kg	
Size	133 mm (height) x 50 mm (depth) x 128 mm (width)	
IP Rating	IP24D	
Nozzle	Operating Pressure	80 – 110 bar
	Flow rate	6 litres per minute
	Spray Pattern	65-degree vertical blade
	K Factor	0.62
Input voltage	24VDC ±10% (reversed voltage protected)	
Minimum nozzle waterway	1.5mm	
Maximum permissible input voltage	28VDC (transient protected)	
Minimum permissible input voltage	22VDC	
Input Current	0.03A Idle Mode	
	<0.5A Scanning Mode	
	~0.5A Servo Stalled	
Operating Temperature	4 - 50 °C	
Operating Humidity	20 - 90% (non-condensing)	

Hoses, Piping, fittings and cables

All piping and fittings should be supplied and installed in accordance with the manufacturer's instructions and should be suitable for use at the pressures and flows to be experienced by Automist with the necessary factors of safety. All these elements should be fixed directly to the structural elements or primary supports of the building. The supports should not be used to support any other services. Pipe supports should prevent the pipe from being dislodged. Supports should be secured in accordance with the manufacturer's instructions. Supports should not be glued, welded, or soldered to the pipe or fittings.

Fittings

- 1/4" BSP Female thread with swivel nut with 60° cone mating surface
- Material: mild steel (zinc plated)
- **NOTE:** do not use stainless steel material for any fitting or hose adapter

Hose General

Approved suppliers of hoses:

Hydroscand (several locations in the UK)

<http://www.hydroscand.co.uk/>

When installing flexible high-pressure hose behind plasterboard walls, **Plumis recommends the hose is left free and unconstrained**. This is because mounting the hose in a conduit or narrow groove within joists makes it more susceptible to perforation when subsequent building works are carried out. Flexible high-pressure hoses must be mounted as close to the ground as possible and within the wall. For cases where the hose is exposed, conduit sleeves must be used. Where the hose is surface mounted more than 1.2m from the floor in a protected room, or where the hose passes above/within the ceiling of a protected room, a suitable thermally insulating sleeve is required.

- 1/4" or 5/16" nominal inner diameter

- Hose working pressure of at least: 150 bar
- Minimum burst Pressure: 600 bar
- **60m maximum hose length if both 5/16" and 1/4" hoses are used, made up with a maximum of 20m 1/4" hose and a maximum of 40m 5/16" hose**
- **50m maximum hose length if only 5/16" hose is used**
- Any hoses crimped by the installer or on-site must be pressure tested to at least 160 bar and checked for leaks, before connection to the Automist pump

Hose with 1/4" Inner Diameter (Up to 20m in total length)

Multiple hose pieces can be connected by tees or connectors with 1/4" BSP fittings. The total length of 1/4" hose in one Hydra system must NOT exceed 20 meters.

Plumis supplied hose lengths of 2m or 4m:

- Minimum bend radius (MBR): 40mm
- Plastic exterior to withstand some abrasion during installation and maintenance works
- Hose is pressure tested in factory assembly to 2X working pressure (300bar, so no site testing is necessary)

Hydroscand supplied 1/4" hose with customized length:

- Minimum bend radius (MBR): 100mm
- Robust rubberised exterior and single or double wire braiding to withstand heavy abrasion during installation and maintenance works and attempts to hammer a nail through from an adjacent wall.
- Single braided: SKU 11011404, Egefex 1 CO
- Double braided: SKU 11021404, Egefex 2 CO
- Weblink: https://www.hydroscand.co.uk/uk_en/product/egeflex-1-co-1101-14
- Hose must be tested at Hydroscand after crimping to minimum 160 bar. In this case, no site testing is necessary.

Hose with 5/16" Inner Diameter (Up to 40m in total length)

Multiple hose pieces can be connected by tee or connector with 1/4" BSP connection. The total length of 5/16" hose in one Hydra system must NOT exceed 40 meters.

Hydroscand supplied 5/16" hose with customized length:

- Minimum bend radius (MBR): 115mm
- Robust rubberised exterior and single or double wire braiding to withstand heavy abrasion during installation and maintenance works and attempts to hammer a nail through from an adjacent wall.
- Single braided: SKU 11011405, Egefex 1 CO
- Double braided: SKU 11021405, Egefex 2 CO

- Weblink: https://www.hydroscand.co.uk/uk_en/product/egeflex-2-co-1102-14
- Hose must be tested at Hydroscand after crimping to minimum 165 bar. In this case, no site testing is necessary.
- Note that you must still be able to use 1/4" BSP Fittings with a 5/16" Diameter hose.

Stainless Steel Piping (alternative to high pressure hose)

- Material: Stainless Steel only
- Stainless steel pipes and fittings must conform to
 - UK (BS 8458:2015): ASTM A269-10 and ASTM A312
 - US (NFPA 750): ASTM A269 or ASTM A 632 or ASTM A 778 or ASTM A 789/ A 789M
- Internal diameter: 5/16" (8 mm)
- Working pressure at least: 150 bar
- Maximum total length: 50m

Hoses, Piping support

In accordance with BS 8458:2015 6.11.2.4, when pipework supports are used, they should meet the following recommendations:

- a) *'Hose or pipework supports should be fixed directly to the structural elements or primary supports of the building.'*
- b) *Hose or pipework supports should not be used to support any other services.*
- c) *Hose or pipework supports should prevent the pipe from being dislodged.*
- d) *Supports should be secured in accordance with the manufacturer's instructions.*
- e) *Supports should not be glued, welded, or soldered to the pipe, hose, or fittings.*
- f) *Where necessary, supports for hoses or pipework should be suitably lined to prevent corrosion and abrasion.*
- h) *The maximum support spacing should be in accordance with the manufacturer's installation instructions.'*

Hydra Data & Alarm Cables

Cables installed into buildings must be compliant with the 'Construction Products Regulations' CPR and certified to European harmonised standard EN50575.

IMPORTANT: The maximum cable lengths for Hydra are indicated below, installation using longer cables is not allowed.

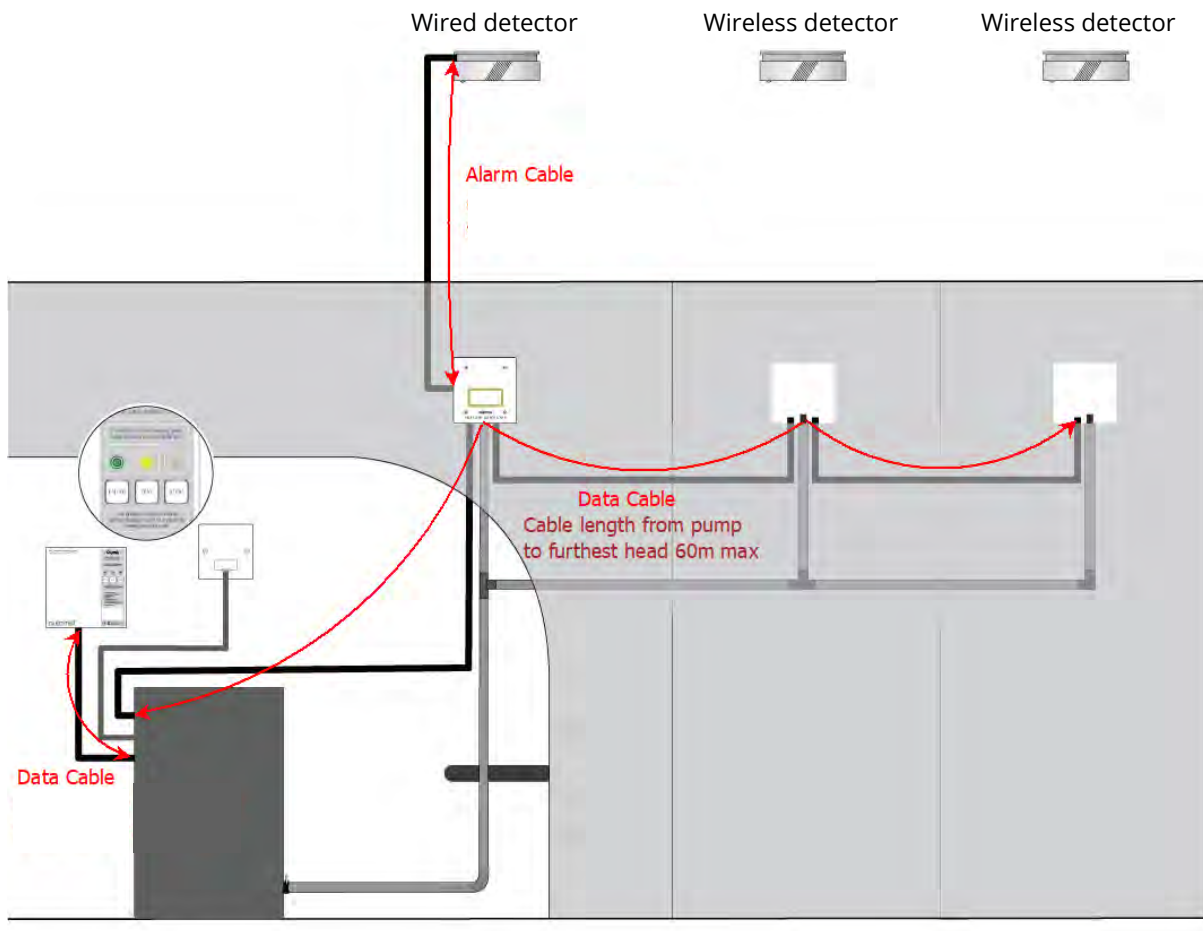

Figure 37: Automist Smartscan Hydra data and alarm cable diagram

Data Cable Specifications

- 2 x 2pair x 22 AWG (0.35mm²) Individually Screened Two Pair LSF Data Cable - Grey
- Each twisted pair individually shielded with outer shield drain wire
- Maximum length of data cable from Controller to Heads 80m, which includes the maximum allowable data cable from pump to the controller of 30m plus the maximum data cable length to the furthest head from the pump of 60m
- Construction Products Regulations classification: Eca or better
- FSC part number: 2202PIFRL-E00 (available in 100, 200, 300, 500m reels)
- Plumis part number: E0012-L

Alarm Cable Specifications

- **Option 1:** 39200202H-E00 (FS Cable SKU)
7-2-2A Defence Standard Single Pair 0.22mm² Unscreened LSHF Cable - Black
Construction Products Regulations classification: Eca or better
Maximum length of alarm cable from Alarm to the furthest Head 20m
- **Option 2:** 39200502H-E00 (FS Cable SKU)
16-2-2A Defence Standard Single Pair 0.35mm² Unscreened LSHF Cable - Black
Construction Products Regulations classification: Eca or better

Maximum length of alarm cable from Alarm to the furthest Head 20m

- **Option 3:** 387FTD103 (FS Cable SKU)

2 x 0.65mm Firetuf Data BS 5839 IEC60331-2 Red LSHF 910234 / 60018006

Maximum length of alarm cable from Alarm to the furthest Head 20m

ONLY use one pair of cables for the wired alarm and leave the other pair of cable and shield wire disconnected



Figure 38: Alarm Cable (39200502H-E00)



Figure 39: Alarm Cable (387FTD103)

Cable options are summarised below:

Cable Type	Plumis Part	Manufacturer	MFG Part Number	Supplier
Data	E0012-L	FSC	2202PIFRL-E00	FSC
Alarm	E0013-L	FSC	39200202H-E00	FSC
Alarm	N/A	FSC	39200502H-E00	FSC
Alarm	N/A	FSC	387FTD103	FSC

Cable Supplier

- FS Cables, Alban Park, Hatfield Road, St Albans, Herts, AL4 0JX, Tel: +44 1727 840 841
- Contact: Lee Girdler, Email: leegir@fscables.com

Wire Terminations

Data and Alarm cables **MUST** be terminated with crimped on bootlace ferrules during second fix, see page 70.

Bootlace Ferrule (mandatory): Multicomp E0508-WHITE, 0.5mm² / 22AWG, pin length 8mm, overall length 14mm.

Detection Devices

Wired or wireless detectors in combination with scanning infrared sensors on the nozzles electronically trigger Automist, acting as an initiation device equivalent to a glass bulb bursting under the influence of heat. If the initiation device (detectors paired to Automist) are removed or faulty, it will cause the system to enter fault mode: persistently beeping sound and red LED flashing (see page 75). This condition can be

silenced for 12 hours by pressing the STOP button but can only be permanently removed by addressing the fault. In this way, unlike with a sprinkler, the points of detection are monitored.

IMPORTANT! As a default, the early warning alarm required for the building is in addition to the detection used to trigger Automist, although they can be integrated (see page 51).

The use with other types of detection not listed by Plumis (see page 49) is discouraged. The Automist system shall only use the detectors/alarms listed on page 49. The use of non-listed detectors could lead to death or injury.

- Placement of detectors/alarms must follow BS 5839-6:2019. Notably this implies a working range of no more than 5.3m for smoke detectors and gives guidance on unusual ceiling types.
- Automist Smartscan Hydra's use of alarm(s) or detector(s) does not affect or reduce any requirements for the use of smoke detection in the property. Smoke detection provides a critical **independent** early warning, especially with slow-growing fires.

Plumis Wireless Multisensor Alarm (DT01)

The Wireless Multisensor Alarm is a 3xAAA battery powered wireless alarm custom designed for use with an Automist Smartscan Hydra spray head only. The alarm has a built-in wireless transmitter, which communicates with the control panel via the spray head receivers. When smoke is detected, the alarm sounds a loud local alarm, and the built-in transmitter sends a signal to the control panel. The Wireless Smoke Heat Alarm contains an integrated fixed 5°C temperature freeze sensor that will send a warning signal based on temperature detected. This alarm is designed to provide protection up to a maximum 21 meters spacing capability. The detector can send alarm, tamper, and battery condition messages to the Automist Smartscan Hydra's controller. Refer to the wireless alarm instructions for more details.

The Wireless Smoke Heat Alarm contains a sounder which generates the ANSI S3.41 temporal 3 pattern in an alarm condition. In alarm, a message is also sent to the control panel. The mounting base installation is simplified by the incorporation of features compatible for both drywall fasteners (not supplied) and other methods.

Specification

- Operating Frequency: 2.4 GHz
- Maximum Transmit Power: 10 dBm
- Protocol: Plumis proprietary
- Detector fault detection, tamper detection, dirty detector, freeze warning, battery low warning
- Compliant to EU Radio Equipment Directive (EN ETSI 300 328, EN ETSI 301 489-17, EN50131-4)
- Powered by 3 AAA PC2400 Duracell Procell batteries (1.5V 1100mAh), or 3 AAA Energizer E92 batteries (1.5V 1100mAh)

Compatible third party detectors/alarms

IMPORTANT! Always follow the manufacturer's instructions when installing wired detectors. A 24-volt wired connection must be made between the detector and the spray head location using fire protected cable. ONLY following wired detectors have been configured with the Automist system:

Apollo Orbis

- Apollo Orbis ORB-OH-13001-APO Multisensor detector.

<https://www.apollo-fire.co.uk/products/range/orbis/smoke-heat-detectors/orb-oh-13001-apo-orbis-multisensor-detector>

- Apollo 65 Series A1R (Only Heat).
<https://www.apollo-fire.co.uk/products/series-65/rate-of-rise-detectors/55000-122apo---series-65-heat-detector-a1r/>

An Apollo heat detector should only be chosen over and above a multisensory detector if it is not possible to use a multisensory detector as the type of substance encounter causes frequent false alarms. Use of heat detectors for code compliance should be verified with Plumis as this type of alarm is slower to react than multisensory detectors.

ONLY the following wired detector bases are compatible with the Automist system and apollo detectors:

- Apollo Orbis TimeSaver Base ORB-MB-00001-APO.
<https://www.apollo-fire.co.uk/products/range/orbis/mounting-bases/orb-mb-00001-apo-orbis-timesaver-base-with-continuity-switch>
- Apollo Orbis TimeSaver LX Base ORB-MB-00002-APO.
<https://www.apollo-fire.co.uk/products/range/orbis/mounting-bases/orb-mb-00002-apo-orbis-timesaver-base-lx-without-continuity-switch>
- For the Apollo A1R heat alarm use base 45681-201APO
- [45681-201APO - Series 65 Base - Diode \(apollo-fire.co.uk\)](https://www.apollo-fire.co.uk/products/series-65/rate-of-rise-detectors/55000-122apo---series-65-heat-detector-a1r/)

Nittan EVC-DP Dual Optical Detector

This is a conventional, 2 wire, EN 54-7:2018 optical smoke detector which is the preferred activation method for Automist, whether used as an independent system from an alarm device or whether driven by a conventional alarm panel. The detector uses a UB-4 or UB-6 base which is compatible to Nittan detectors. Operating voltage of 12VDC to 36VDC. Quiescent current of 50µA @ 24V and alarm current of 50mA at 24V.



Figure 40: Plumis DT02 detector

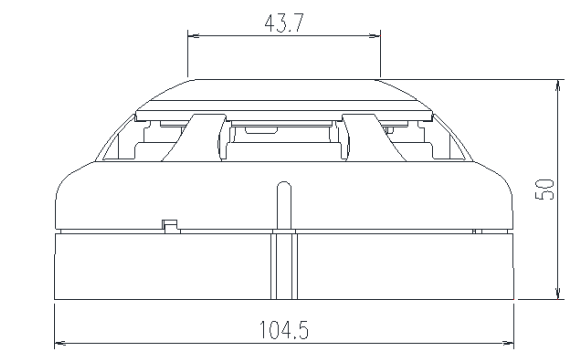

Figure 41: Plumis DT02 dimensions

The options below should ONLY be used when integrating with other alarm systems (see page 51):

AICO

- Ei3024 Multi-Sensor Fire Alarm (kitchen only)
<https://www.aico.co.uk/product/ei3024-multi-sensor-fire-alarm/>
- Ei3016 Optical Smoke Alarm
<https://www.aico.co.uk/product/ei3016-optical-smoke-alarm/>

The following relay base is compatible with Automist, because it monitors the detector status and has an in-built battery backup in case of power loss:

- The Ei414 RadioLINK + Fire/Co Alarm Interface provides either a wireless interface via RF between a Radio Link, RadioLINK+ and SmartLINK Alarm systems. As well as a physical (hard-wired) interface via a link cable between Warden Call/ Telecare systems. The Warden Call System in turn is programmed to perform the desired function, on receipt of these signals. The Ei414 Fire / CO Alarm Interface can be used to connect Ei Electronics RadioLINK Alarm Systems to suitable other Systems such as Fire Panels, Telecare Systems, Auto Diallers, Security Systems etc. The Ei414 has 3 output relays for Fire, CO & Service that can be triggered by an Ei Electronics RF Alarm System.
- These relays can be directly connected to Automist. The Ei414 must be House Coded to the other RadioLINK devices in the system.
<https://www.aico.co.uk/downloads/ei414-instructions>

Integration with other alarm systems

IMPORTANT Where the protected premises are to be fitted with automatic fire detection and alarm systems, they should be in accordance with BS 5839 and be to at least the minimum grade and category recommended in BS 5839. It is important to ensure that, prior to the installation of a fire detection and fire alarm system, one organisation has accepted responsibility for compliance with the relevant section of BS 5839. The Standard emphasises this point because it is possible for more than one party to be involved in the process of design through to installation, alarm and Automist commissioning.

When the Automist system is being integrated with 3rd party detection other than the models listed above, care must be taken to ensure that the reaction time of the detector being used is no longer than the reaction time of the models specified above.

NOTE Detectors can have longer activation times and still comply with BS5839

1) Domestic

Typically, a domestic alarm system is completely independent of the Automist installation because, as a default, the alarm system (regardless of grade) has already been specified and installed to meet the early warning need for means of escape. In this scenario, Automist will use its own detectors and alarms to initiate the scanning for the fire, but these are above and beyond what is already present for the early warning purpose, provided by the independent alarm system. As a result, BS 5839 requirements apply in full to the alarm system but do not apply to Automist as it is not being used for early warning purposes. The requirement for a mains powered and battery back-up alarm is a common source of confusion. It is required for the alarm system but not for any suppression system in a domestic installation, unless the occupancy and risk demand increased resilience or robustness beyond the typical installation (see page 22).

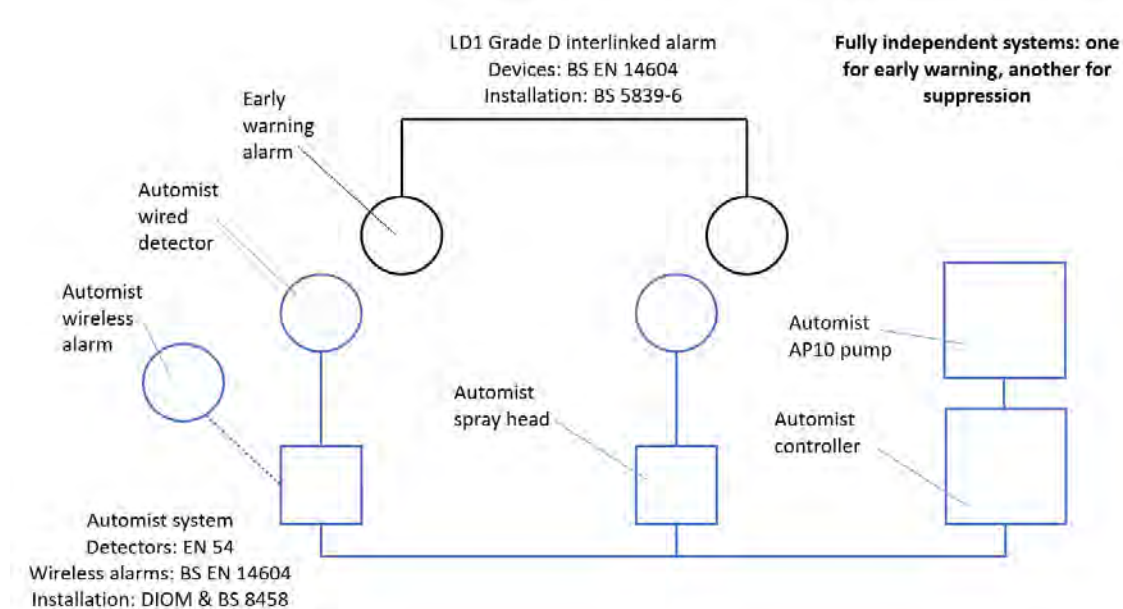

Figure 42: Early warning and suppression system independent systems

Alternatively, a Grade D (or higher) standard fire alarm system might have been specified for the premises, together with an Automist system. Smoke detectors will be sited in hallways and landings at all floor levels, and they must also be sited in all habitable rooms and areas where a fire might start that communicate with the stair enclosure.

Automist can use the LD1 fire alarm system as an initiation device if early warning detection is present in all the areas to be protected by suppression, that enough zones can be created, and that the specification is of, at least, a Grade D.

IMPORTANT! Maximum of 3 heads per zone. Small zones are preferable because it is easier for the system to find the fire if it is searching through less area.

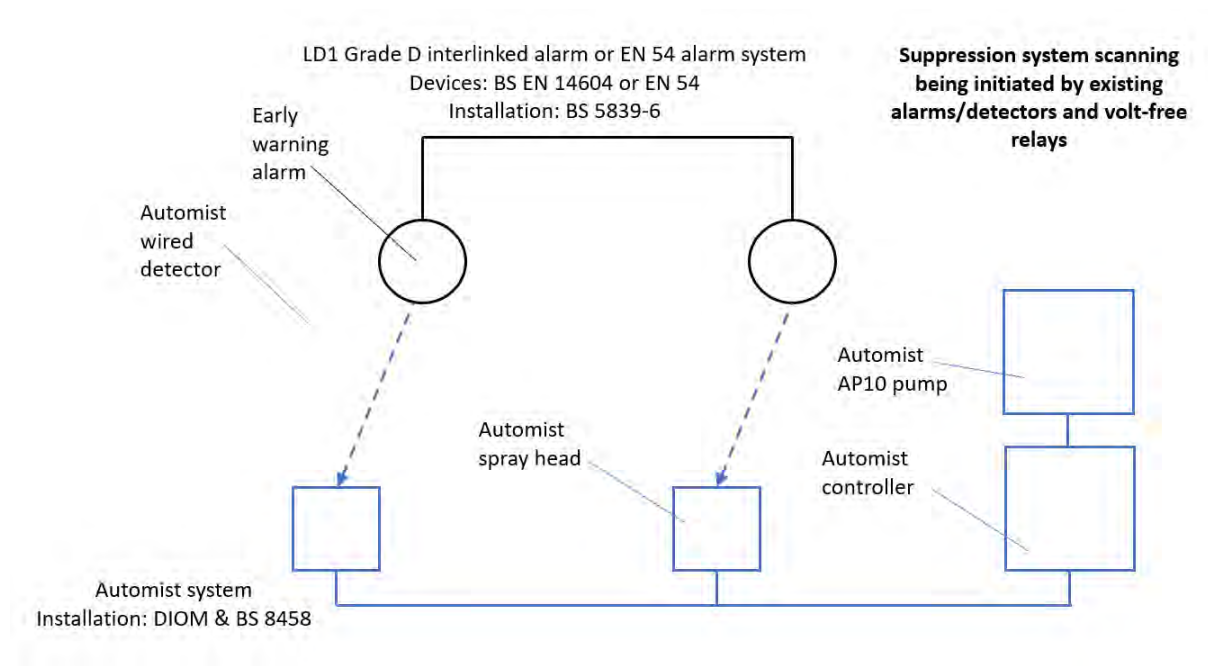

Figure 43: Volt-free detector relay bases used to initiate the scanning of Automist

A volt-fire relay is required to initiate the scanning of Automist for each zone. This can be provided by using a detector/alarm base with a relay output and wiring that volt-free relay to the spray head with a resistor pair to simulate the effect of the detector, replicate the high impedance state of a stand-by detector and the low impedance state of an alarming detector, as shown below.

The selected alarms or detectors use must meet the requirements of BS EN 14604 or BS EN 54, respectively, while the installation should be in accordance with BS 5839-6:2019.

Where a fire alarm panel is used, alternatively, the volt-free outputs can be provided by the panel itself, where every volt-free output identifies a zone. As with the relay base volt-free contact, to simulate a detector for Automist, it is necessary to use a pair of resistors as per the diagram below. The relay output (with resistors) must be connected to a Hydra head in the zone it is protecting.

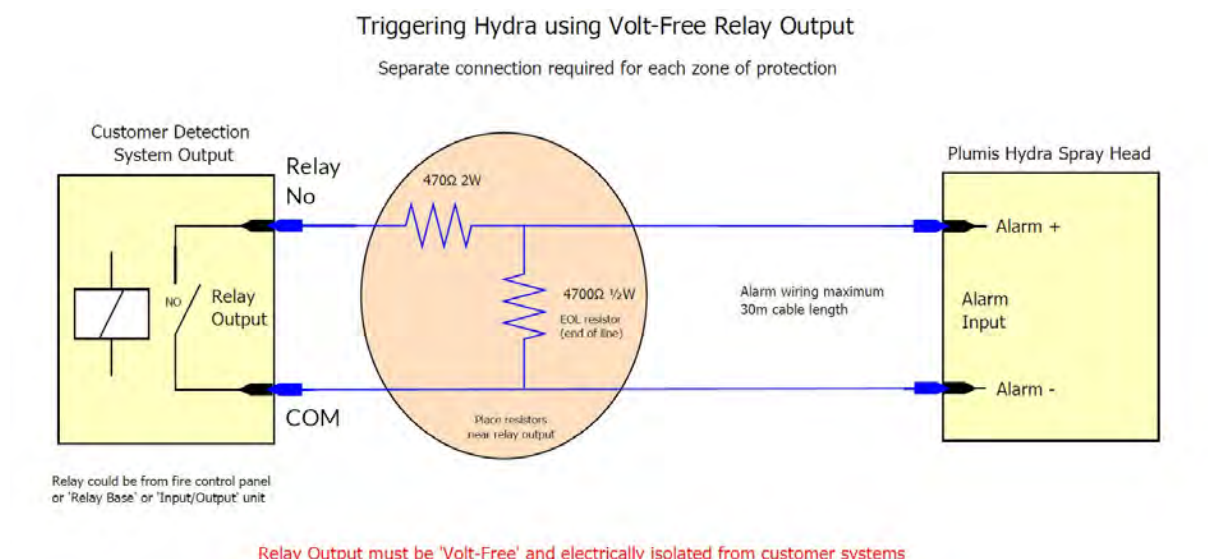

Figure 44: Triggering Automist with a Volt-free Relay Output

The system can be used as a twin wire system (enabling base sounders to be incorporated). This type of setup would require consideration of the battery requirements, as for domestic systems 72 hours standby (as required by either BS 5839-1:2017 or BS 5839-6:2019) + 30-minute alarm time would be required. This would typically mean an additional battery box may be required as most panels will only house 7ah batteries.

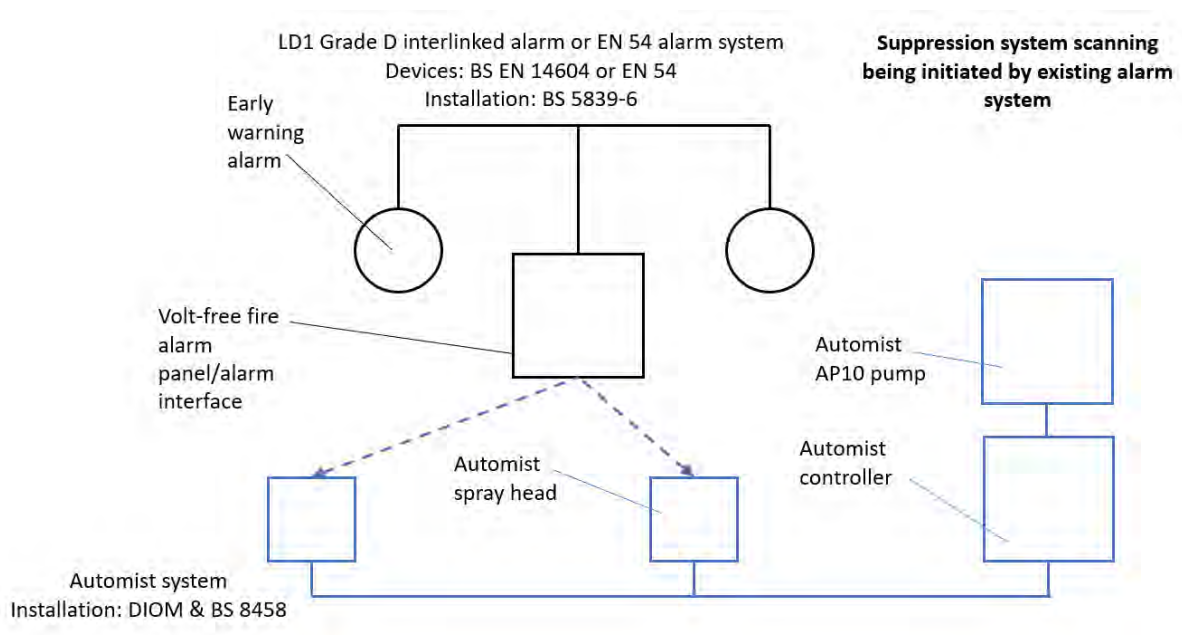

Figure 45: Volt-free fire panel or interface used to initiate scanning of Automist

When using an addressable system it is possible to program the multisensory detector in the room to activate an output relay that in turn triggers the Automist system. Addressable systems allow a lot more flexibility in the programming and cabling, and typically can house bigger batteries, whereas most addressable fire panels can house 12ah as standard.

IMPORTANT! Caution must be used in utilising higher sensitivity detection, such as aspiration systems, which will cause heads to scan for a fire (but not to spray watermist) in case of sensitive detection of smoke. By altering the detection method utilised on the fire testing of Hydra against BS 8458, and if the application is to meet Building Regulations, the specifying installer is taking responsibility to ensure the activation time of detection is no longer than the time it would take an EN54 multi-criteria smoke + heat detector to detect a fire.

2) Residential

In multi-storey blocks of flats, the Automist may be configured to output a confirmed fire in an "Automist zone" to the building's alarm panel. Because the Automist zone is typically a room, this gives much better accuracy on the location of a confirmed fire than is typical with traditional suppression systems, which provide a confirmed fire signal only for an individual floor, or for the whole building. This is achieved by using an Automist pump with a relay output, product code: AP10.

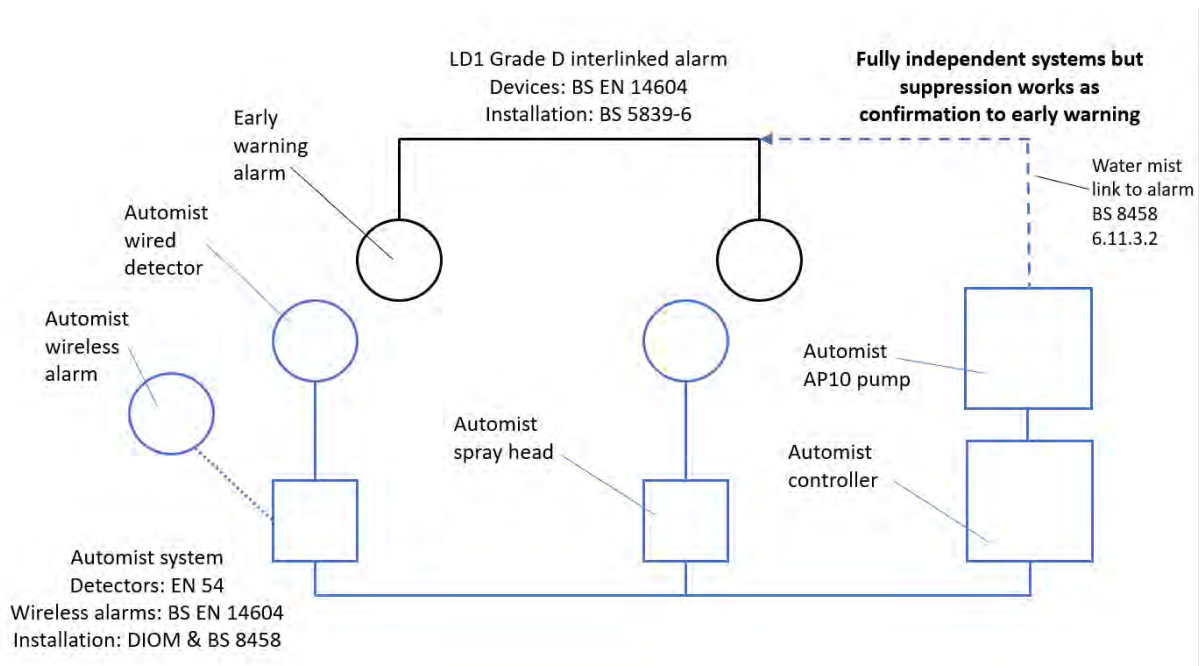

Figure 46: Watermist system linked to alarm system to provide fire confirmation as per BS 8458 6.11.3.2

The Automist AP10 pump flow output should meet one of the following recommendations. See page 77 for connections

- The output should be connected to an audible alarm.
- Provided that the property is fitted with an automatic fire detection and alarm system meeting at least the minimum grade and category recommended in BS 5839, the output can be interlinked to this system. The automatic fire detection and alarm system should be in accordance with the recommendations of BS 5839-1:2017 or BS 5839-6:2019 as appropriate.
- The alarm signal should be configured and acted upon in accordance with the fire strategy for the building.

Transmission of alarm signals to alarm receiving centres

Where a Automist has been installed for the protection of vulnerable people, it is essential that the activation alarm (AP10) is also transmitted to an alarm receiving centre or to a permanently staffed a place where people are tasked with responding on a 24/7 basis, so that management action can be initiated, and the fire and rescue service mobilized. BS 5839-1:2017 or BS 5839-6:2019 provides more detailed guidance and recommendations.

Controller

The controller is 155 mm (height) by 42 mm (depth) by 155 mm (width), weighs 0.38kg and has an IP rating of IP45. It should be positioned near or next to the consumer unit, or alternatively, next to the pump. It should be stored in an area that is a separate compartment from the protected volume and accessible for the person responsible for maintenance or someone who may require access to the stop button. In managed occupancies, such as sheltered accommodation, it is beneficial for it to be accessible without requiring entry to individual flats. The controller persistently produces a warbling sound and shows a red LED flashing when the Automist System is in fault and requires attention.

Valves

A WRAS approved isolation valves is required so that the Automist Smartscan Hydra system can be shut off from the water main. All such valves must be labelled with the included warranty void anti-tamper label. This enables clear identification of any tampering with the water valve (note: spare stickers can be ordered from Plumis).

The product is also supplied with a non-verifiable single check valve assembly (suitable for backflow prevention up to Fluid Category 2), for installation between the isolation valve and the PRV, in accordance with *Figure 2*. Maximum working pressure: 10.0 Bar. Cold water use only.

The single check valve supplied with this product must be installed to maintain the validity of the WRAS approval.

A full flow test is performed as part of the commissioning process (see page 84 for full details), after which water is pumped out of the supply hose or pipe using a bicycle pump or an air compressor pump.

Electrically operated devices

In accordance with BS 8458:2015, *'the electrical supply to the Automist pump should be installed in such a way as to minimize the risk of electrical supply failure by having a separately fused connection taken after the meter and from the supply side of the domestic or residential fuse box, using fire-resisting cable'*.

Strainer

The Automist strainers is made of corrosion resistant material with the flow direction given on the body. It should be installed in each water supply connection (see page 78 - Connecting the Water Supply).

Mechanical Specification:

- 2-piece filter (head and jar), complete with cartridge
- 80µm mesh, less than 0.8 times the area of the smallest orifice in the system
- Head: reinforced polypropylene.
- Vase: transparent SAN.
- O-ring: EPDM.
- Cartridge: washable. Filtering net Polyester.
- Applications: filtration of sand, scales, silt, fine material.

Fire pumps

The Automist fire pump is a positive displacement pump designed to discharge a constant flow of 6 litres per minute because only one Automist spray head will ever discharge at a fire, as this is electronically controlled. The Assumed Maximum Area of Operation (AMAO) is always a single spray head and therefore the pump only needs to supply the flow and pressure for that one spray head.

It will operate automatically once a fire location and risk has been determined by the controller and will stop operating after 30 minutes (default operation time) or if shut down manually at the controller.

The Automist pump should be:

- a) located such that it is unlikely to be affected by a fire;

- b) located where the temperature can be maintained above 4 °C;
- c) protected electrically by suitable fusing;
- d) protected against the effects of fire; and
- e) suitably protected against corrosion

To mitigate overheating when running for long periods, the pump must be installed in one of the following locations with clearance of 100 mm at front and rear:

- In an enclosure (room or cupboard) with volume of at least 0.124m³, that is separated by a fire resisting partition from the mist-protected room(s) that it serves. Alternatively, a flame proof enclosure (G0001_M) can be purchased from Plumis for purpose of protection, to minimise the effect of a fire to the pump when it is in the room it is trying to protect.
- In a cupboard with volume of at least 0.124m³, within a room that the pump serves, with the top of the pump less than 80cm above finished floor level.

Additional clearance at the front and the rear of the pump must also be provided to accommodate the connections.

Automist Pump Specification

Weight	7 kg	
Size	365 mm (height) x 240 mm (depth) x 181 mm (width)	
IP Rating	IP24D	
Pump Unit	Operating Pressure	80 – 110 bar
	Flow rate	6 litres per minute
	Rated Speed	3460 rpm
	Inlet Pressure (Static)	1 – 6 bar
	Pression Spike	125 – 135 bar
Input Voltage	(Class I system protective earth)	230VAC ±10% 50Hz
Input Current	Pumping Mode	1.7kW, 8A maximum
	Scanning Mode	30W, 0.5A maximum
	Idle Mode	2W maximum
	Cold Start Inrush	45A
Output Voltage	IN port (controller)	24VDC ±2.5%
	OUT port (spray heads)	24VDC ±2.5%
Output Current	IN port (controller)	1.1A maximum current limited
	OUT port (controller)	1.1A maximum current limited
	IN + OUT total current	1.3A, 30W, overload protected
Operating Temperature	4 - 55 °C	
Operating Humidity	20 - 90% (non-condensing)	

Pump with an output relay (AP10)

Automist's (AP10) pump can output an alarm signal, and its functionality should be integrated into the protected premises in a way which is compatible with the fire strategy for the protected premises. In all cases, the relay should generate a fire alarm signal that initiates the appropriate emergency procedures.

Automist may be interfaced with the fire detection and fire alarm system, so that a fire alarm signal is given by the building's fire alarm system when the Automist pump operates. Automist has a high level of reliability in fire situation, coupled with very few unwanted actuations, an alarm generated by the alarm device needs to be treated as a confirmed fire signal. Pump model AP10 has an output relay allowing a volt free to be sent to any panel/receiver device when the pump is activated. Alarm system designers need to

take account of the fact that the pump flow alarm might have more than one function, e.g. to initiate evacuation, to alert management and/or alert the fire and rescue service.

Automatic test and monitoring facilities

The Automist pump is not wet pipe and does not need to be churned to maintain reliability. It is a positive displacement pump and locked motor rotors is addressed under the EN60335 standard part 19 'Abnormal Operation'. It is possible to fit a power loss alarm to the system, to alert the user if power is cut. Because the alarm is installed to detect a loss of power, it must be installed on a separate spur of the same circuit as the Automist system.

Automist is also continually monitored through an RS-485 bus connecting every key component and raising a warning if one item is faulty or has been tampered with or removed.

The Automist system does not include a battery back-up as a default and therefore a power loss will not be indicated in the system, it will only be observable by the lack of the green LED on the controller. A local power loss alarm can easily be added to the system if the application demands its use. Alternatively, the power supply can be remotely monitored using third-party hardware.

Electrical design and installation

Electrical installations should conform to BS 7671.

IMPORTANT! The maximum allowable data cable length in the system is 80m (from the controller to the pump to the furthest head). It includes the maximum allowable data cable from pump to the controller of 30m plus the maximum data cable length to the furthest head from the pump of 60m.

Additives

Additives should not be used with Automist Smartscan.

Trunking and Pump Enclosures

Fireproof trunking can be used to house the spray heads and conceal the associated hose or pipe for ease of retrofit.

When the pump is placed in the protected area or there is the need to prevent the occupant from tampering with the pump and water inlet, the pump and filter should be housed inside a fireproof enclosure which is fastened to the wall. The volume of the enclosure must be at least 0.124m³

Any pump enclosures and trunking should be made from materials specially designed for the enclosure of suppression system, typically referred to a "sprinkler boxing". The fire rated sprinkler boxing should be suitable for use in internal dry conditions as defined in EN622 part 5. Materials of this type are suitable for use in Hazard Class 1 of EN 335-3 and should also be compliant with Euroclass B standards. All paint coatings used on FRSB products are coated with flame retardant BS EN Class B s1 d0 paint.

INSTALLATION

Installation Procedure

- A) First Fix - Preparing the site
- B) Second Fix - Installing the controller
- C) Second Fix - Installing the spray head(s)
- D) Second Fix - Connecting the water supply
- E) Commissioning

Notice!

Equipment you will need:

During first fix:

- A suitable tool for tightening BSP hoses, e.g. wrenches
- A set of screwdrivers including Torx bits
- A suitable electric drill
- Electrical cable
- Pipe sealant

During second fix:

- A pressure gauge kit (CM01) (available from Plumis)
- A commissioning kit (CM06) (available from Plumis)
- A suitable tool for tightening BSP hoses, e.g. wrenches
- A set of screwdrivers including Torx bits
- A suitable electric drill
- Electrical cable
- Bicycle pump or air compressor with Schrader valve connector
- Pipe sealant
- Torque Screwdriver: Duratool DT000230 (CPC)
- Screwdriver Bits: Tacklife HPSB1A 58-in-1 precision screwdriver bits (Amazon)
- Heat/smoke gun
- Hose parts and crimping tool (if making hoses on site)

A) First Fix - Preparing the site

Mains Electricity Installation

IMPORTANT! Connecting the system to the mains requires a competent electrician with 18th Edition Electrical Qualifications. The Automist Smartscan Hydra circuit must be clearly labelled (a label is provided for this purpose). Automist Smartscan Hydra requires an independent 230V A.C. / 50Hz electrical supply, not shared with other unrelated devices. The Automist Smartscan Hydra system, fire detection and alarm system may use this circuit, which must remain powered in the event of a fire. Power to Automist Smartscan Hydra must be provided via an unswitched fused connection unit (FCU). Automist Smartscan Hydra must be supplied using FP200 cable or better, ideally inside conduit or protected 50mm deep within a wall, and with Miniature Circuit Breaker (MCB) and a Residual Current Device (RCD) (C type), or Residual Current Breaker with Overcurrent (RCBO) (C type) protection. RCD or RCBO protection may be required, however, by applicable electrical installation regulations, in which case the circuit design must be such that the operation of any other RCD, RCBO or safety device does not affect the operation of Automist Smartscan Hydra. An RCBO is preferred because if there is a fault on any one circuit it does not interfere with any other circuit. Typically, on a split-load board, Automist Smartscan Hydra must be connected to the non-protected side of the board. Where there are no spare ways in the existing consumer unit, or there are no available non-RCD protected ways in the existing consumer unit, the electrician may wish to use a Henley Block to provide new tails to a second distribution board (typically a 2- or 4-way unit) with no spare ways for future use. When prepay meters are present an additional prepay meter should be added specifically for Automist and housed within a lock box. The prepay meter for Automist must then be maintained with credit beyond its expected lifetime usage as part of the annual maintenance cycle.

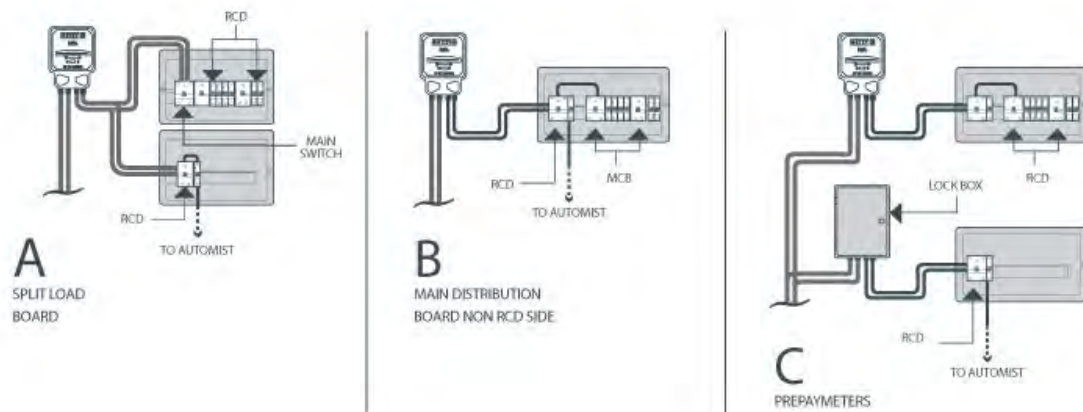

Figure 47: Electrical supply variations

WARNING! Switch off electricity at the mains before working on existing circuits.

The AP08 pump is intended for domestic and residential use only and therefore is of overvoltage Category II and has a Rated Impulse Voltage of 2.5kV. Depending on installation circumstances surge protection devices across the incoming mains supply might be required. The Automist Smartscan Hydra unit presents an inductive motor load and therefore only type "C" breakers are suitable. Because Automist Smartscan Hydra is often used for life safety applications, installers must add a suitable safety margin to the MCB ratings. By protecting the circuit supplying an Automist Smartscan Hydra with a C type breaker ('C10' or 'C16' for one unit (per pump), or 'C20' / 'C32' for two Automist Smartscan Hydra units) this safety margin is

achieved. This must be on a C-type breaker, on an RCBO or an RCD protected circuit. **The RCD/RCBO circuit must protect only the Automist Smartscan Hydra system and not be incorporated with any other circuit in the property.** If the consumer unit is in the protected area, it must be protected by an electrical cover. However, if the consumer unit is in the protected area and has a metal enclosure complying with 18th Edition IET Wiring Regulations to BS 7671 2018; it does not require the addition of an over box to meet BS476 Part 22 (1987) and EN1364 (1999). To follow the requirements of BS 8458 it may require the use of fuses rather than MCBs, as a: *'separately fused connection taken after the meter and from the supply side of the domestic or residential fuse box'*.

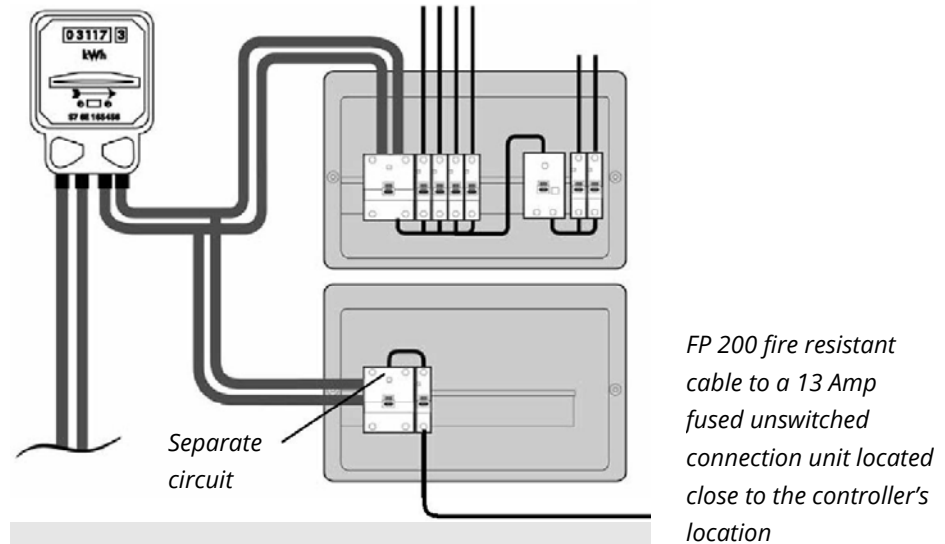

Figure 48: Split load board power supply

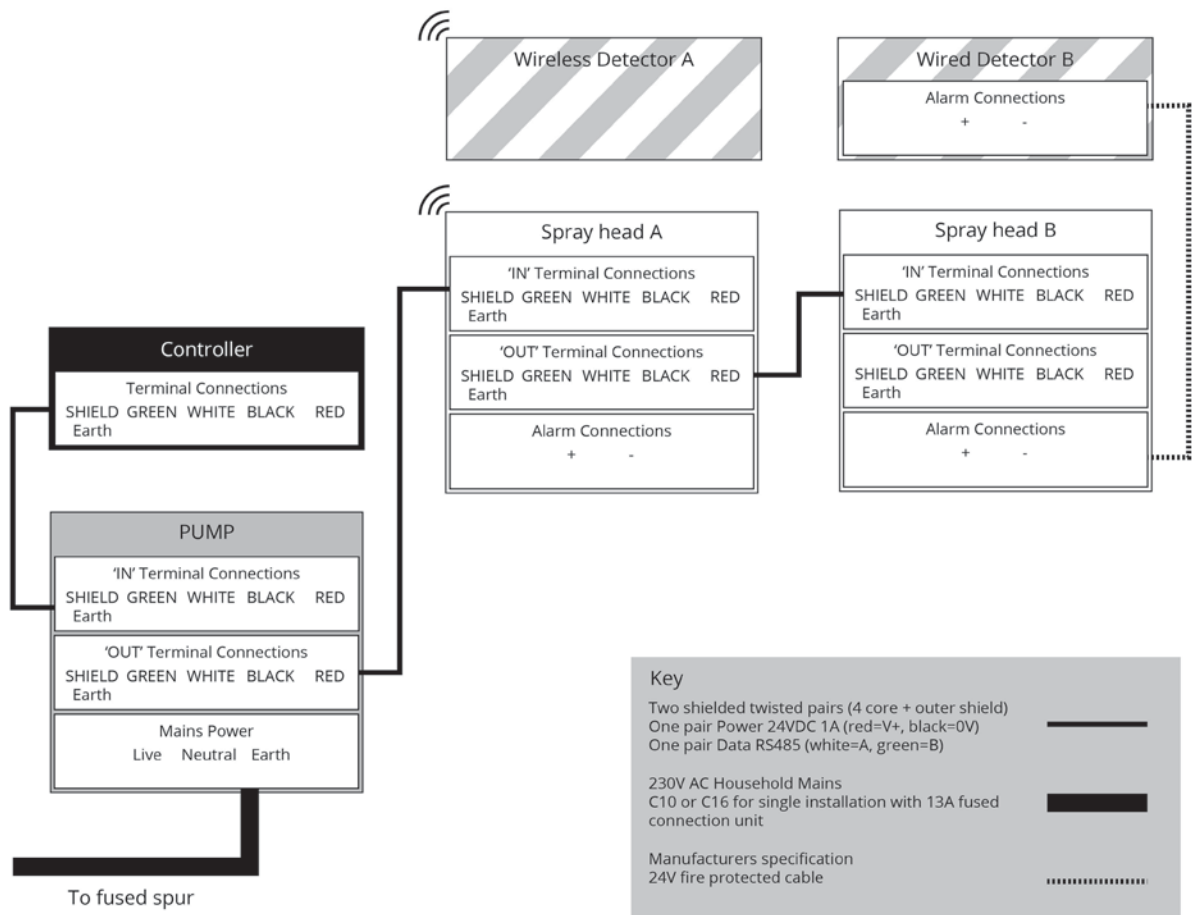

Figure 49: Electrical Connection Diagram - 2 spray head system with a wireless and wired detector

The intention of the first fix is to set up and verify the water supply and power supply to the pump and install the high-pressure hose(s), data cables and the electrical cables. This must be completed following the layout plan which has been preapproved with the Authority Having Jurisdiction, so the installation and commissioning can be completed with the system set up as it would be in service.

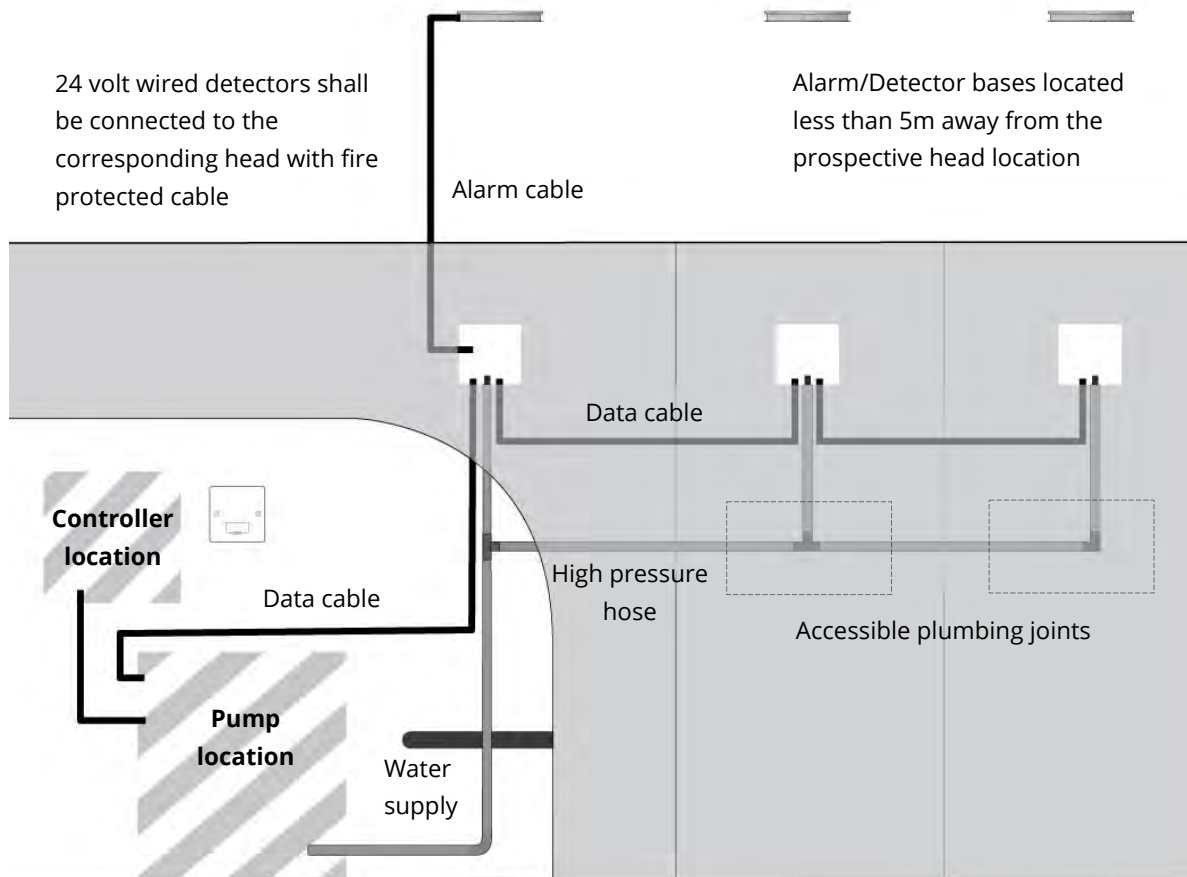

Figure 50: First Fix Setup

Mains Water Installation

Install a 3/4" water supply (connection) with a WRAS approved isolation valve positioned so that the connection point will not be obstructed when the pump is installed. The cold-water supply must deliver the following flow and pressure:

- Minimum 8 litres per minute flow
- 1.5 – 6 bar pressure static water pressure

If these cannot be met, a priority valve or a booster pump will need to be used to reach these minimum required values. An outside pipe diameter of less than 28mm is a good indicator that a survey is required. Verification of the flow and pressure provided by the specific 3/4" water supply pipe is required. Photographs are recommended with the measuring equipment in place.

The water inlet assembly and pump, which is water-filled, should be located in an area of the property where exposure to temperatures below 4 °C can be avoided. If this cannot be ensured, the location of this water-filled pipework should be protected against freezing. The high pressure hoses do not need to be protected against freezing as they are kept dry until pump discharge.

High Pressure Hoses Installation

IMPORTANT REMINDER! Before installation ensure the hoses are in line with Plumis guidelines. See Hoses, Piping, fittings for high pressure hose specification on page 44. The maximum total length of high-pressure hoses is 60 m. The maximum allowable hose with a nominal diameter of 1/4" is 20m, and maximum allowable hose with a nominal diameter of 5/16" is 40m when the two hose types are used in combination, with the total length not exceeding the 60m limit. A 5/16" only installation may have a maximum length of 50m.

High pressure hoses can be connected in a star or a daisy chain configuration. See page 44 for high pressure fitting specification. Any plumbing joint or fittings **must be made of galvanised steel**, e.g. t-connectors, elbows, must be housed in an accessible area so they can be checked for leaks during the commissioning procedure.

IMPORTANT! Hoses must be closed with caps to prevent contaminants from entering the water path until the second fix.

It is recommended that the hose is installed at least 40mm from the surface of walls to avoid being affected by protruding nails or screws.

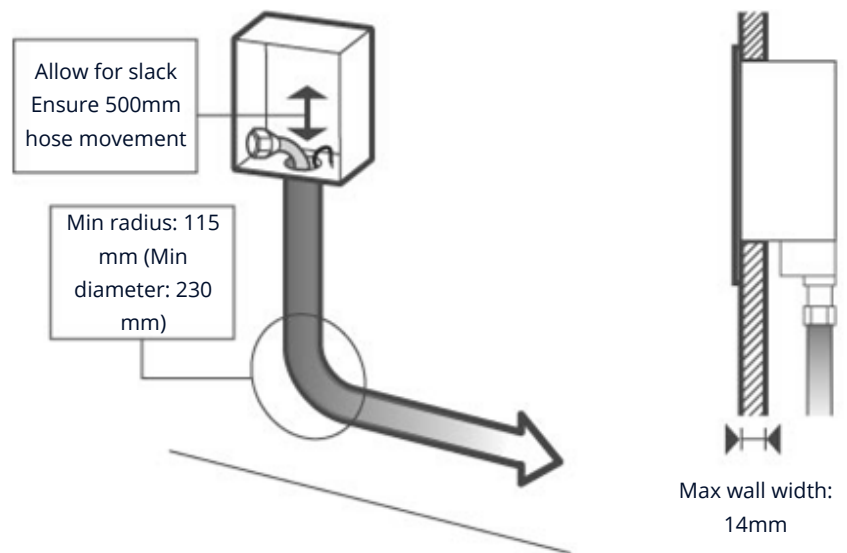

Figure 51: Mounting the Back Box and using metal conduits

IMPORTANT! Different types of hoses have different min bending radius (see technical data sheet). Steel elbows must be used if minimum radius cannot be met.

IMPORTANT! When installing into solid walls, solid metal conduit must be installed to allow for movement of the hose (500m slack) for future servicing and replacement of the hose. Solid metal protection must also be used when the hose is restricted of lateral movement. This is necessary because when the hose is not free to move it is more susceptible to being punctured accidentally. The hose or pipework should be installed in accordance with this manufacturer's design and installation manual and should be protected against internal corrosion. Structural timbers should not be notched or bored in such a way that the integrity of the structure is compromised.

IMPORTANT! So that fire separating is effective, every joint, or imperfection of fit, or opening to allow services to pass through the element which has fire resisting function, should be adequately protected by sealing or firestopping so that the fire resistance of the element is not impaired.



Figure 52: Example of mechanical protection within a joist

Data Cables Installation

The spray heads are set up in a daisy chain configuration (see page 74), therefore **data cables must be labelled IN and OUT** during first fix so they can be correctly installed when connecting the spray heads during the second fix. It is recommended that the data cable(s), where possible, is loosely bound to the high-pressure hose.

Fire Stopping

IMPORTANT! Fire stopping is required to close an imperfection of fit or design tolerance between elements or components, to restrict the passage of fire and smoke. Joints between fire-separating elements such as compartment walls or floors, should be fire-stopped to maintain the continuity of resistance; and openings for timber beams, joists, purlins and rafters, and pipes, ducts, conduits, or cables that pass through any part of a fire-separating element should be kept as few in number as possible, kept as small as practicable, and fire-stopped. Effective fire-stopping requires good awareness of technical literature and standards, and effective inspection of works on site. This is particularly important where fire-stopping may be left to the end of the construction process, installed by a subcontractor, or where it is concealed.

When fireproof trunking is used to house the spray heads and conceal the associated hose or pipe for ease of retrofit and the hose is run downwards from the ceiling inside the trunking, two galvanised steel 90-degree elbows shall be used to avoid the risk to the long-term reliability of the hose due to the resulting bend being smaller than manufacturer's specified minimum bend radius. During the hose cutting and installation, the end of the hose shall be relaxed inside trunking at the level between 60-100 mm below the lower edge of the window in the trunking, as per figures below.



Figure 53: Correct trunking installation with double elbows



Figure 54: At risk trunking installation with hose bending

Install the two elbows to the inlet port of spray head in the orientation that the 180-degree bend is pointing to the back side of the spray head. Tighten the two connections with wrench. Connect the hose inside the trunking to the spray head and tighten the connection with wrench. Install the spray head to the trunking and gently guide the slack of hose inside the trunking.

Detector and/or alarm installation

Detectors and alarms must only be installed by a competent engineer/technician. Dust caps must remain (be placed) on the alarm up until the occupant moves in to avoid contamination by building works dust. Integration with an existing alarm (see page 51) must be performed by a specialist who is certified, fully qualified and registered by a third party (e.g. BAFE) to ensure high quality of work. When installing a compatible detector, alarm, or fire panel (see page 49) refer to the manufacturer's instructions.

DO NOT install detector (or alarm):

- Directly over a sink, cooker, stove, fireplace, or oven
- Do not locate a detector within 1.5m of any cooking appliance (as per the manufacturer's recommendation)
- Next to a door or window that would be affected by drafts i.e. extractor fan or air vent
- Outside
- In or below a cupboard
- Where air flow would be obstructed by curtains or furniture
- Where dirt or dust could collect or block the sensor
- Where it could be knocked, damaged, or inadvertently removed
- Adjacent to, or directly above, heaters, air-conditioning vents, or ceiling fans
- In an area where the temperature may fall below 4°C or rise above 37°C
- In such a position that it is difficult or dangerous to reach for testing or maintenance or where children can easily tamper with the alarm

- In an area where water or other liquids may enter the alarm, except in the extremely unlikely case that the alarm and its connections are waterproof (e.g. bathrooms)
- On surfaces subject to significant vibration

Ensure Automist Smartscan Hydra is only paired to the desired detector(s) in the volume it protects. These associations can be verified using the product’s ALARM TEST MODE (see page 94). In this mode, alarms may be triggered which will cause their linked heads to perform two scans and then return to an idle state. Ensure that Automist Smartscan Hydra has been successfully returned to the System OK state following this test.

IMPORTANT! - The maximum quantity of alarms in one Hydra system is 16, which is the sum of wireless and wired detectors. The total number of wired detectors in a system must be 6 or less. The number of wired detectors in a series chain must be 3 or less. All the wired alarms in series will be considered as “one alarm” by the system.

For the correct wiring of wired detectors, follow the enclosed installation instructions supplied with the detector. Additionally, an End of Line (EOL) resistor should be added across the terminals specified by manufacturer. Resistors must be 4.7K ohm, 0.5W, 1%, such as Multicom MF50 4K7. EOL resistor must only be added to the last detector in the chain:

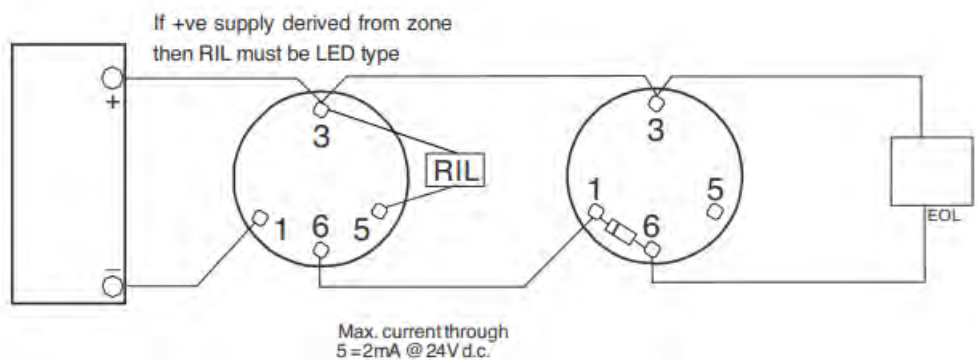

Figure 55: Wiring for Plumis DT02 wired detector

Similarly, a resistor is placed between the OUT+ and COM- terminals in the detector base of Apollo Orbis ORB-OH-13001-APO Multisensor detector.

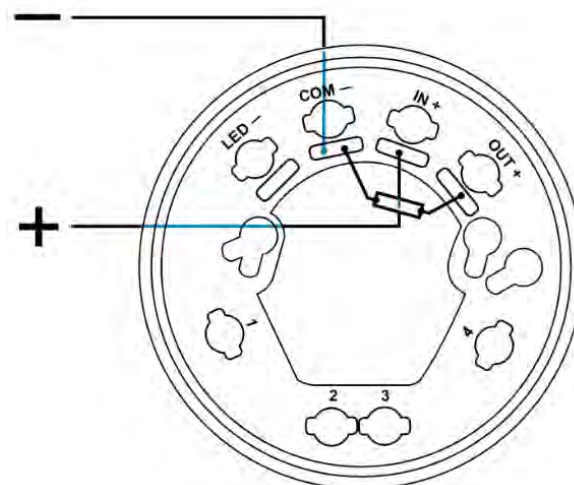

Figure 56: Mounting the resistor on wired Apollo detector

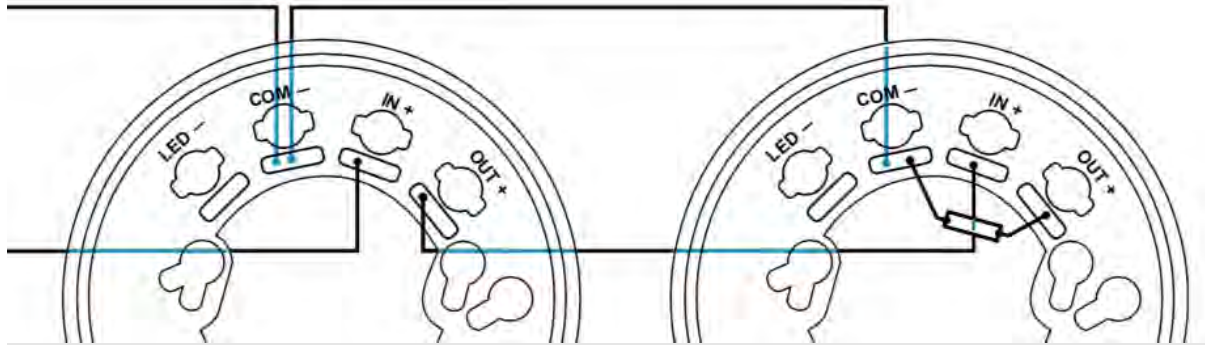

Figure 57: Mounting the resistor on wired Apollo detectors in chain

Plumis Wireless Smoke Heat Alarm (DT01) Installation

Once a suitable location is found, mount the alarm as follows:

1. Refer to the diagram below and install the mounting base on the ceiling or on the wall (if permitted for the application) using the screw location as required. Use the two screws and anchors provided. Manoeuvre the base so the screws are at the elbow of the screw slots and secure.
2. Fit the alarm inside the base aligning it over the base as shown (alarm alignment notch must be slightly offset from mounting base tamper release tab), then turn the detector in a clockwise direction until it clicks into place.

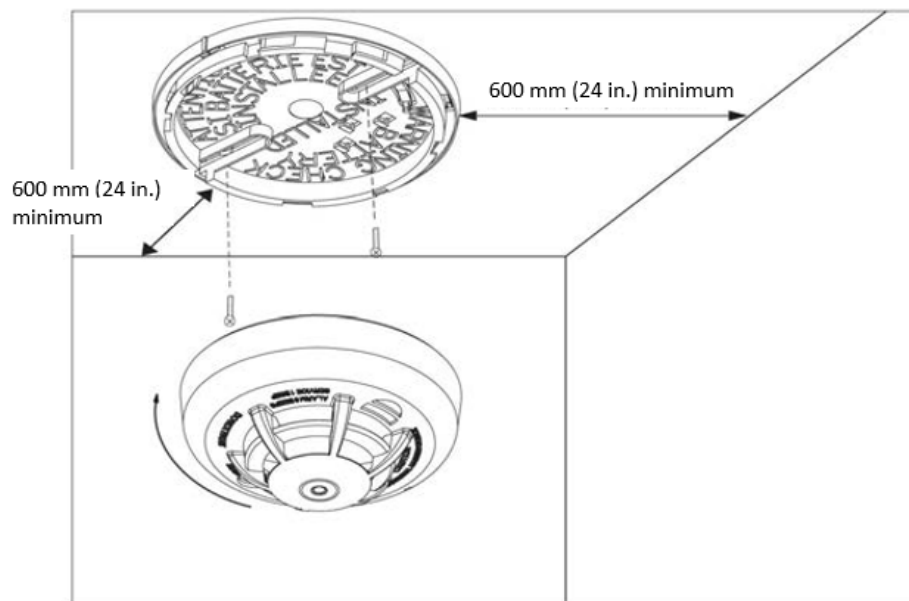

Figure 58: Mounting the detector

During initial power-up the alarm's LED blinks alternately red, yellow then green. After approximately 8 seconds, the power-up internal procedure will have been completed and, if the alarm is functioning normally, the green LED will blink once every 12 seconds.

IMPORTANT! Constant exposure to high or low temperatures (below 5°C) or high humidity will reduce battery life.

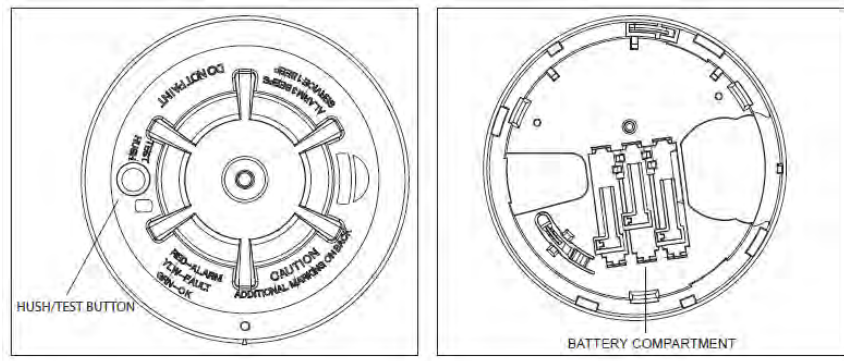

Figure 59: Diagram of DT01

B) Second Fix

High pressure hose pressure test

It is recommended to carry out the following leak checks on the high-pressure hoses / pipes after installation:

Pneumatic Test

High pressure hoses / pipes must be tested pneumatically to a pressure of not less than 2.5 bar for not less than 24 h. Any leakage that results in a loss of pressure greater than 0.15 bar for the 24 h must be corrected.

Hydrostatic Test

This test must be carried out immediately after the pneumatic test, or as soon afterwards as climatic conditions permit. High pressure hoses / pipes must be hydrostatically tested for not less than 2 h, to a pressure of 1.5 times the maximum pressure to which the system will be subjected. For the Automist system, it is recommended to use 165 bar as test pressure (1.5 x 110 bar). If the system fails to maintain the test pressure, the fault (such as permanent distortion, rupture, or leakage) must be found, corrected and the test repeated. Users must ensure all air is removed from the hoses / pipes network before undertaking a hydrostatic test. Following testing hoses / pipes must be drained and dried to remove any moisture in the network.

Installing the controller

WARNING! The controller must be positioned in a safe and dry location where it is easily accessible, the button will not be pushed accidentally, and the front panel remains visible.

Mount the controller in the selected location. It is recommended to install the controller next to the main distribution board or RCD. The maximum allowable data cable length from the pump to the controller is 30m. Take care to avoid any cables and pipes that may be buried in the walls.

IMPORTANT! Connecting the power requires a suitably qualified & competent person. Switch off electricity at the mains before working on existing circuits. Take care not to touch the PCB. Do not over tighten the terminals.

Carefully Remove the lid of the controller enclosure and fix the back plate which holds the electronic printed circuit boards (PCBs). There is a ribbon connector between the front and back enclosure panels, which can be gently slid off from its pin header connector.

Feed the wires through the gland provided on the bottom of the controller, or through the rear entry hole on the same surface as where the PCB is mounted. The gland also provides strain relief. Grommets are provided and must be placed to fill the cable entry holes which you do not use.

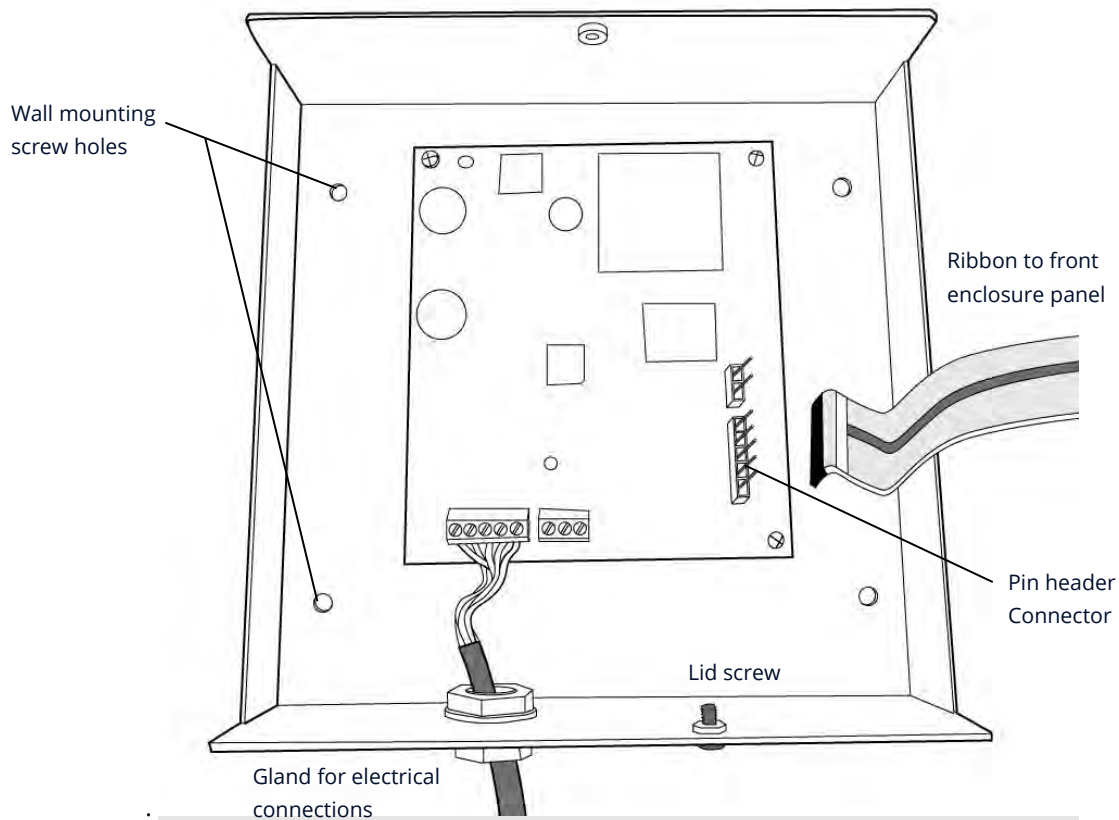

Figure 60: Connecting the controller

Connect the wiring to the terminals as per the drawing (Figure 14). Use a torque screwdriver on the following setting: minimum 0.22Nm, maximum 0.25Nm. (Note: the green connector block has Phoenix Contact MKDS 1/5-3,5).

Data and Alarm cables **MUST** be terminated with crimped on bootlace ferrules as shown below. The individual wires must have insulation stripped back from wire ends approximately 15mm before the ferrule is fitted.

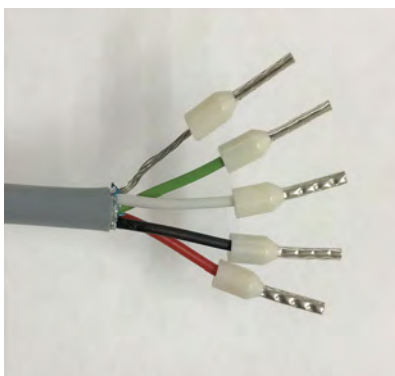

Figure 61: Data Cable (2202PIFRL-E00)

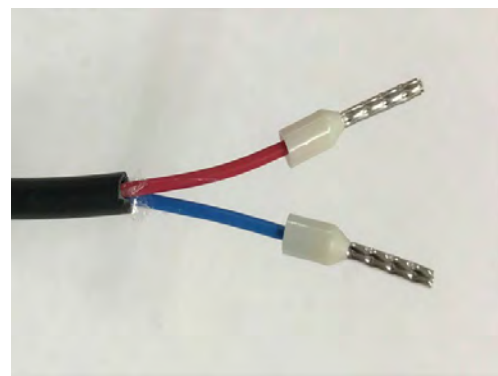

Figure 62: Alarm Cable (39200202H-E00)

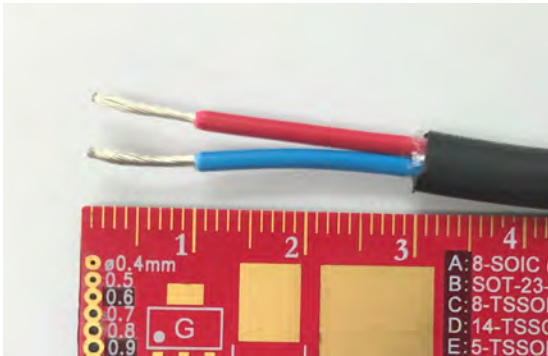

Figure 63: Cable (39200502H-E00) 30mm jacket crimped removed, 10mm insulation removed.

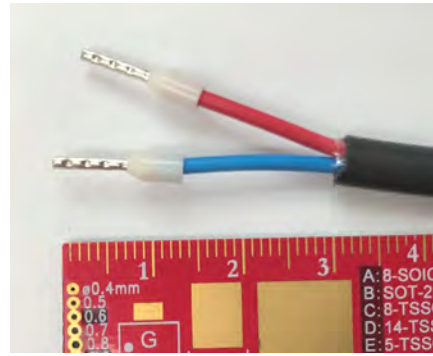

Figure 64: Cable (39200502H-E00) 0.5mm² ferrules

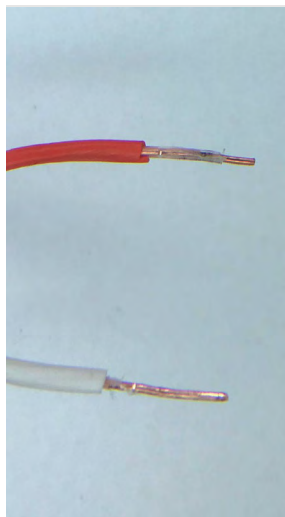

Figure 65: Cable (Firetuf 387FTD103) silicone insulation.

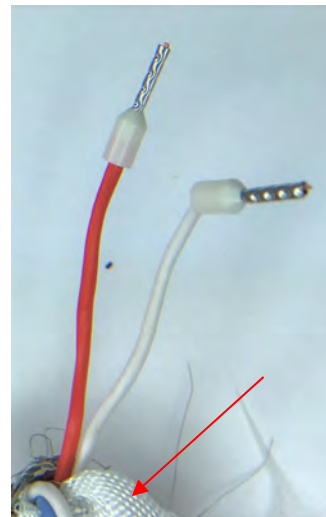

Figure 66: Alarm Cable with 0.5mm² ferrule

IMPORTANT! Stripped back 10mm, note the clear silicone inner insulation (red arrow) must also be removed (see [Figure 66](#) **Error! Reference source not found.**).



Figure 67: Bootlace Ferrule

Crimping Tool: 0.25-6mm² / 23-10 AWG range.



Figure 68: Crimping Tool

- Torque Screwdriver
- Screwdriver Set

Reconnect the ribbon to the pin header connector. Place the control unit enclosure lid over the base and secure the lid.

Installing the spray head(s) and pump

Place the **first spray head** loosely in the mounting hole and connect the data cable between the terminals on the pump to the incoming terminals on the spray head.

Before inserting wire into the terminal, ensure that the terminal is fully open/down by rotating terminal screw ANTI-CLOCKWISE 4-5 turns until end-stop, clutch will click with further turns.

Hydra connections use 'Rising Clamp' type of terminal. Very important to operate the terminals correctly, otherwise they will not make reliable electrical connection and won't properly clamp the wire.

After inserting wire turn screw clockwise until tight. Use a torque screwdriver on the following setting: minimum 0.22Nm, maximum 0.25Nm. (Note: the green connector block has Phoenix Contact MKDS 1/5-3,5). Test connection by Gently pulling on wire to confirm it is not loose.

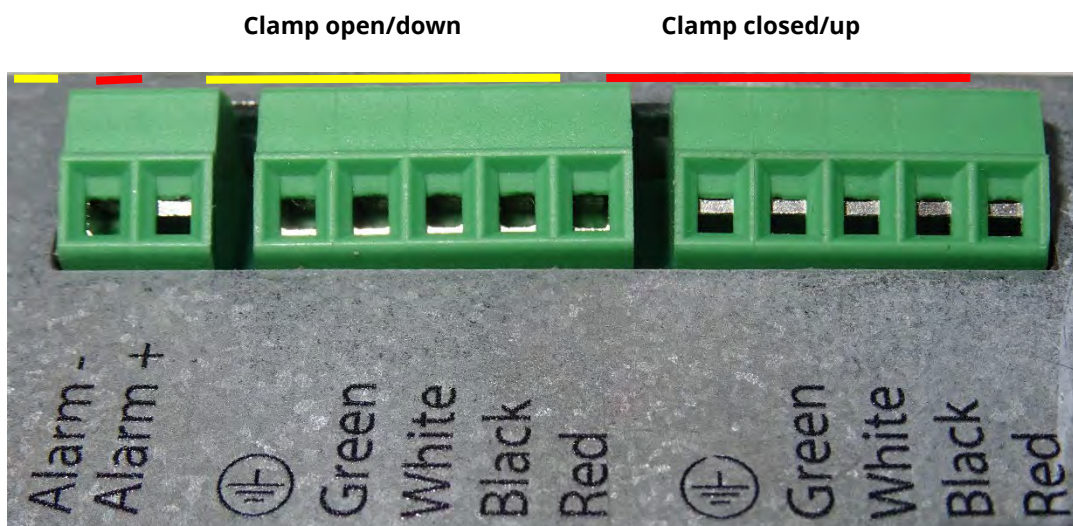

Figure 69: Screw terminals on the spray head

✓ Correct connection

* Bad connection

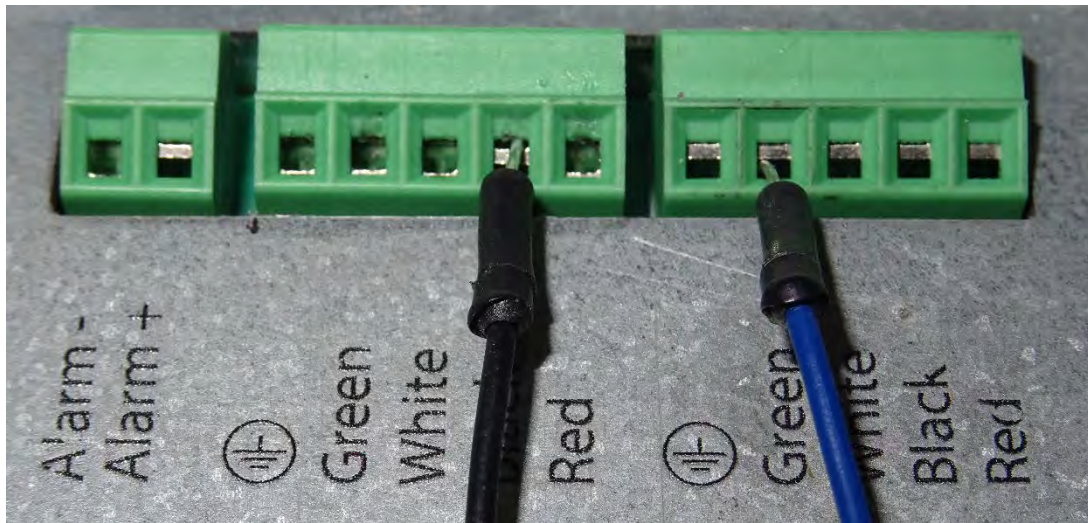

Figure 70: Connections on the spray head

IMPORTANT! Tighten the cable strain relief gland to ensure that any movement of the cable does not result in movement or tension at the terminal block. **Do not over tighten the terminals.**

Connect labelled data cables to corresponding IN and OUT Terminals

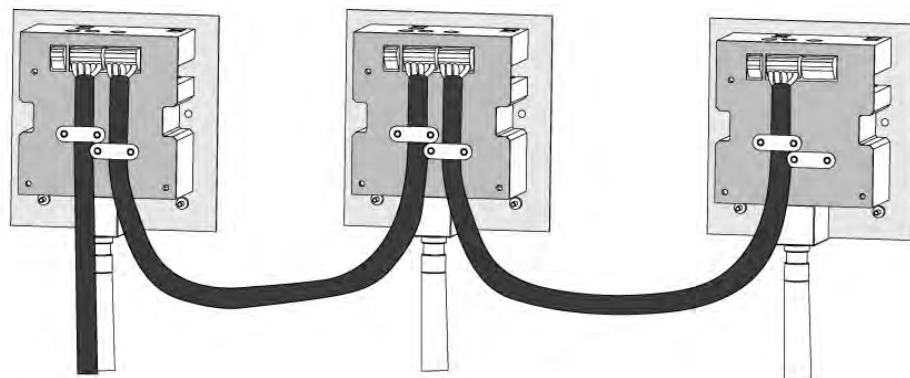

Figure 71: Spray head daisy chain connection

If you are using a hardwired alarm, connect the detector to the spray head with a 24v fire resistant cable.

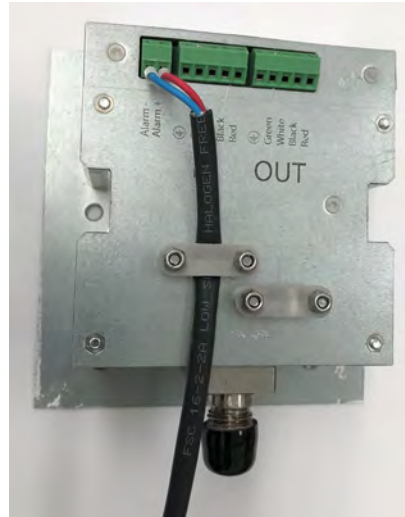

Figure 72: Alarm cable in spray head alarm connector

IMPORTANT! Do not use PTFE at the head connection. If you believe any contaminants or construction products have entered the hose flush it through with water before connecting it to the spray head. The seal between the spray head and fitting is made by a matching 60° cone and therefore requires no washers or sealant.

Connect the ¼" BSP high pressure hose to the spray head assembly

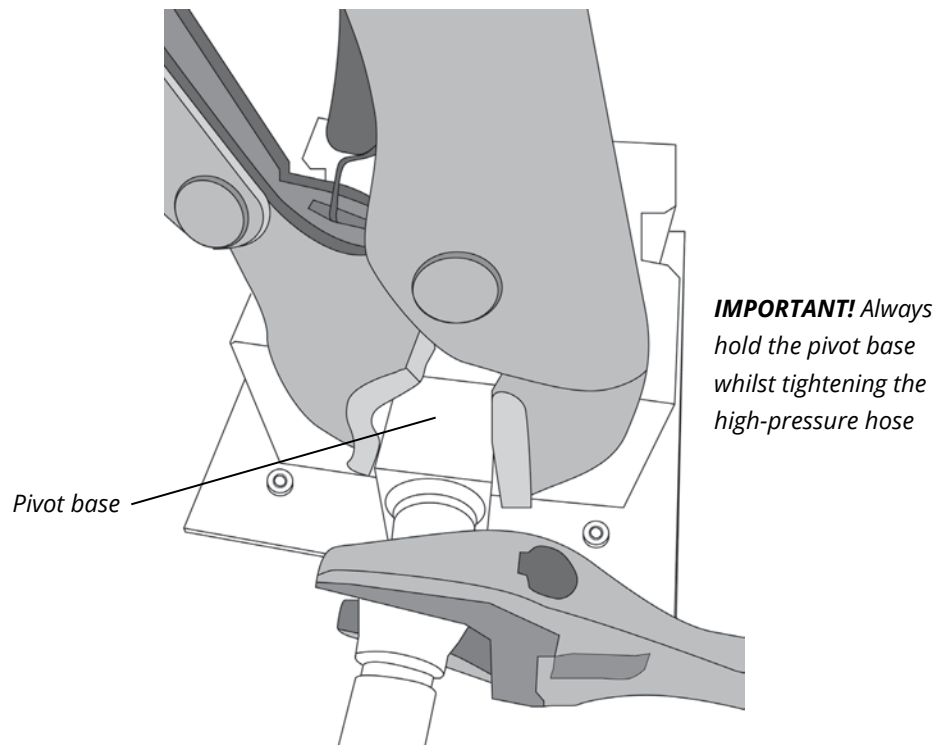

Figure 73: Spray head water path connection

Position the pump unit as closely as possible to the mains water supply pipes. Open the front panel and connect the wiring to the terminals as per the drawing (see page 63). The large gland near the top of the unit is used to supply the power.

IMPORTANT! Tighten the cable strain relief glands to ensure that any movement of the cable does not result in movement or tension at the terminal block.

Once you have successfully connected the controller to the pump, connect the pump to the first spray head and to the mains. Once you have finished with the wiring close the front panel, now you are ready to test the first head.

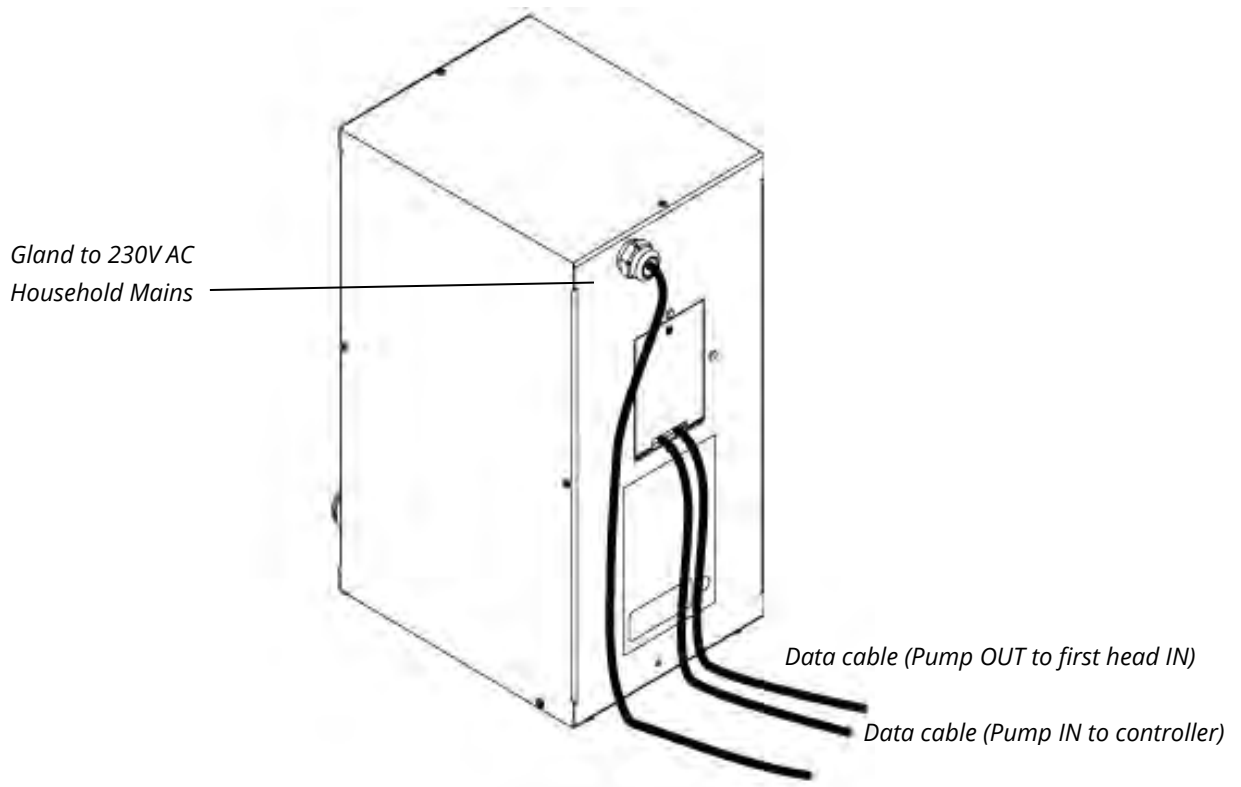

Figure 74: The pump front panel

IMPORTANT! Ensure the live connections are correctly installed and not exposed before switching on the system for the first time. If you have configured the wiring correctly for the first head, the controller will chirp and display solid yellow. All connected heads will light yellow. This indicates that the wiring is correct, and the units are in an uncommissioned state.

The AP10 pump has an additional 3 core alarm cable from a secondary gland on the pump's enclosure. This cable is connected to the pumps relay. this relay offers a voltage free connection for integrating to 3rd party equipment when the pump activates.

The load being connected to this relay contact should not exceed 1amp and 30V DC

Blue wire = Common

Red wire = Normally Closed

Green wire = Normally Open

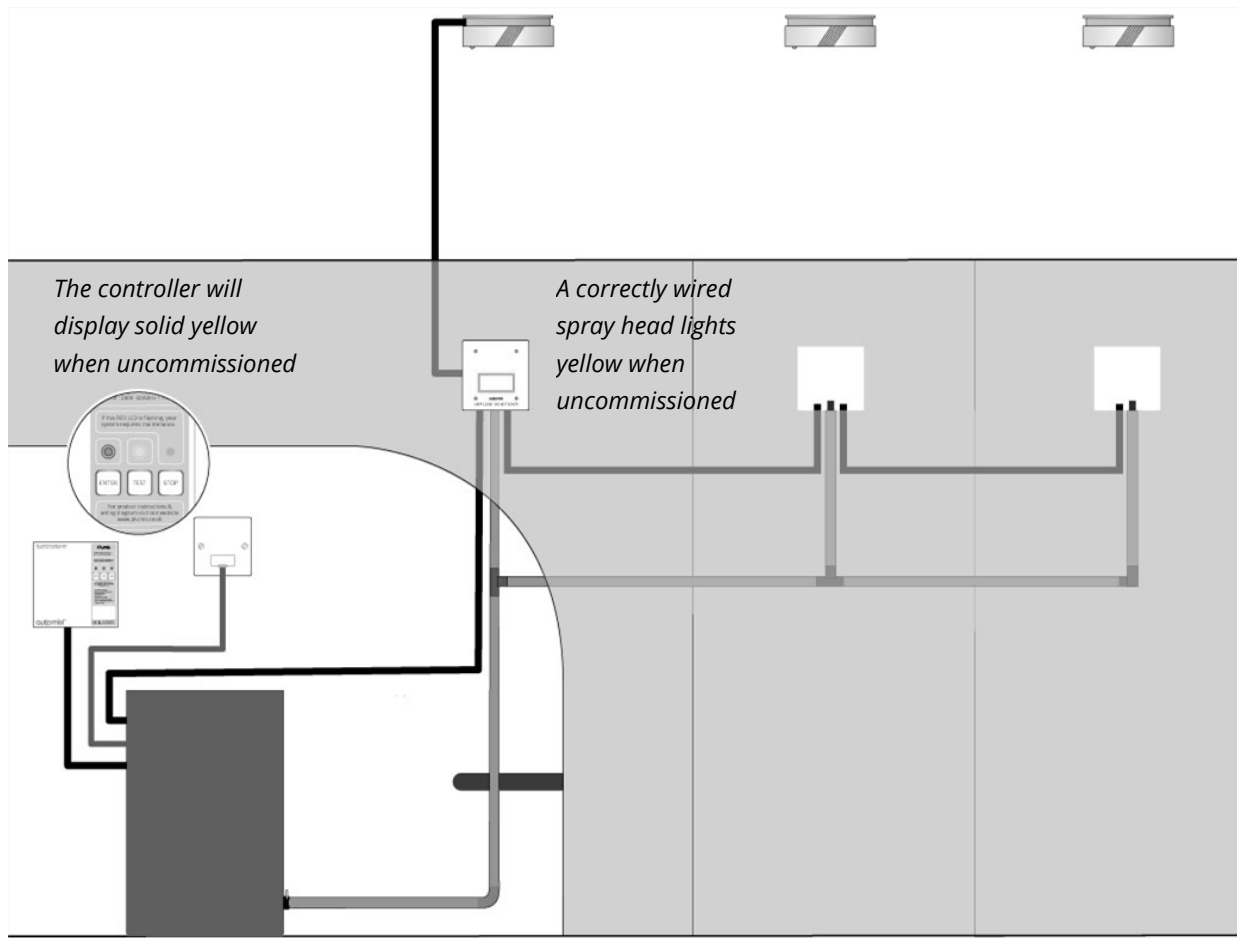

Figure 75: Testing the initial setup

Power down the system and connect the next head. Repeat the process above for each additional head. Installing the system in this way will ensure you can identify if one of the heads has been wired incorrectly. If you are confident that your system is wired correct you can wire all the heads at the same time and verify them at the end.

Connecting the Water Supply

IMPORTANT! The flow to a fire suppression device must be ensured when using a domestic water supply. A survey must be carried out to ensure that there will be water supply available for the Automist pumps and the normal domestic supply in its worst condition. Otherwise, a priority valve or a booster pump must be used to provide the required flow and pressure. It is responsibility of the installer to verify the water supply to the Automist pumps complies to the requirement (See Section Water Supplies on page 41).

The water supply must comply as follows:

- A check valve must be installed to ensure back flow protection to the mains water (supplied in kit).
- PRV must be installed to protect the system from overpressure or water hammer.
- A pipe sealant should be used to avoid leaks between the non-return valve, the PRV and the nipple. The pipe sealant must be compatible with metals.
- See *Figure 2* for installation sequence.
- WRAS approved isolation valves are required so that the Automist Smartscan Hydra system can be shut off from the water main. All such valves must be labelled with the included warranty void anti-tamper label. This enables clear identification of any tampering with the water valve (note: spare stickers can be ordered from Plumis)

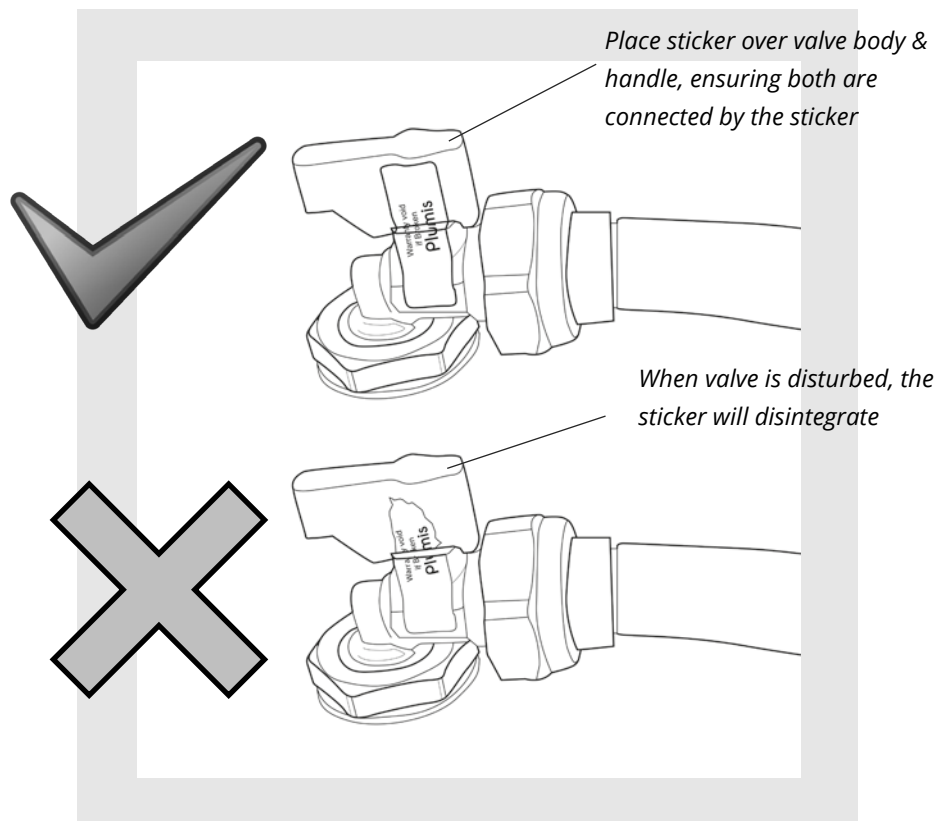

Figure 76: Water valve tamper label

- Priority valves are not normally required but must be used in circumstances where the water supply may otherwise be inadequate.

IMPORTANT! If new pipe has been fitted, it must be flushed out so that any contaminants can be removed before connecting to Automist Smartscan Hydra, to avoid clogging the nozzle.

IMPORTANT! Before planning and installation, it is recommended to carry out a study on hose routing regarding minimum hose length for the connecting multiple heads to the Automist pump. Connect the high-pressure hose from the assembled head to the outlet on the pump.

High pressure hoses left exposed in the protected volume, particularly at height, could be compromised in a fire. Hoses must therefore be encased in the wall whenever possible. Where possible, hoses must be run low in the room, all other factors being equal, and in any case the locations of hoses must be chosen so that they will not be exposed to temperatures above 100°C.

A Quick Connect with Test Point and locking pin are supplied with the AC03 kit to connect the high-pressure side of the pump to the spray head. A small O-ring is included and already attached to the Quick Connect with Test Point. The locking pin retains the quick connector in the pump outlet but can be easily removed, for example to drain water from the high-pressure hose. The Test Point adaptor is required as part of the commissioning procedure (see page 81).

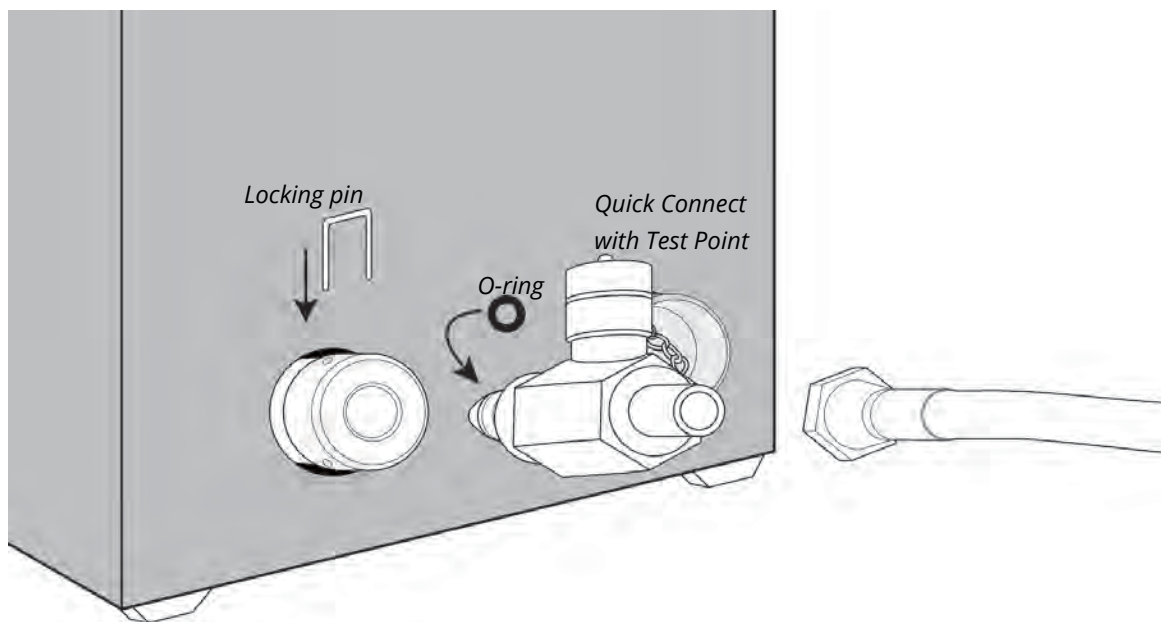

Figure 77: Connecting the Quick Test Point

IMPORTANT! Do not attempt to operate the pump without the quick connector O-ring. Always properly replace the quick connector, O-ring, and locking pin after removal.

Assembly Order, as per Figure 2.

- a) 3/4" BSP water supply
 - i. WRAS approved isolation valve
 - ii. Non return valve
 - iii. PRV (use pipe sealant on both sides for sealing)
 - iv. BSP 3/4" nipple
 - v. Washer
 - vi. Filter
 - viii. Washer
 - vii. Hose

v. Washer

b) Pump

IMPORTANT! Do not install the filter directly to the pump. You must maintain the Assembly order as described above! The new hose-sets supplied with the appliance are to be used and that old hose-sets must not be reused. To enable a consistent pressure and seal for all low-pressure water interface washers, the correct amount of torque must be applied to each low-pressure connection. This can be accomplished in 2 ways (with the washers and mating surfaces kept dry):

i) Apply 6Nm using a calibrated torque wrench

OR

ii) Hand tighten the hose. Using a conventional wrench, apply another 1/2 turn clockwise to guarantee a reliable seal.

IMPORTANT! Switch on the water supply. Check and verify that there is no leak at any component between the main water supply port and pump inlet port when the water supply is switched on. Switch on & off any water tap nearby several times to simulate water hammer effect and verify that there is no leak at any component.

C) Commissioning

IMPORTANT! Commissioning is required:

- Once all the components of the system have been installed and the system is powered.
- As part of a yearly maintenance cycle.
- If plumbing or construction work takes places, new alarms are installed, or maintenance work occurs which could affect the system.
- Commissioning must be performed annually by an Authorised Automist Smartscan Hydra Installer.

Commissioning must only take place when the system is in its 'ready for service' state.

IMPORTANT! The controller lid must be screwed closed when performing this procedure.

When Automist Smartscan Hydra is powered up for the first time the YELLOW LED will remain solid to indicate that the system has not been commissioned. Commissioning is a simple programmed procedure which allows Automist Smartscan Hydra to be tested. During commissioning, the pump runs for 60 seconds, and the output pressure and water flow are monitored.

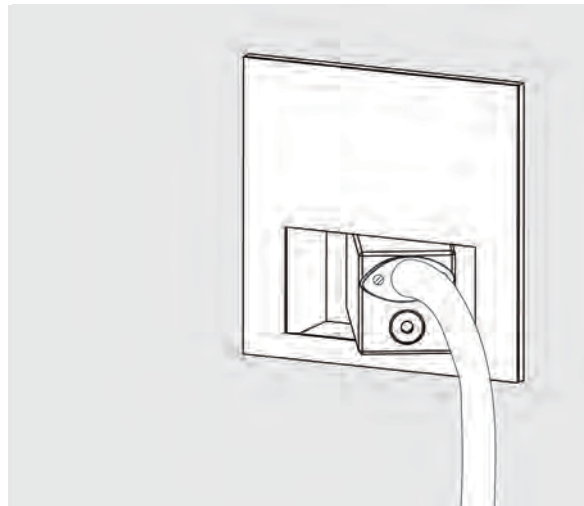

Figure 78: The spray head connected to the commissioning tool

Use the Automist Smartscan Hydra commissioning tool (kit CM06) during the procedure to prevent mist being sprayed into the room. The spray nozzle and the screws holes to affix it are only exposed during the commissioning procedure and at the stage at which it is required, at which point, the spray head will be locked perpendicular to the wall. Use the provided screws and rubber gasket to fasten the tool in place and put a bucket with an approximate 6lt level mark) under the hose during the test procedure.

The Automist Smartscan Hydra Controls



Figure 79 : The Automist Controller

STOP Button: Pressing the STOP button during a fire condition will stop the Automist Smartscan Hydra pump for 2 minutes. After activation, the system will alarm for 12 minutes. During this time if at the end of the first 2 minutes (during the last 10 minutes), an alarm triggers the system will reactivate. This mode was created to address the fire returning in the 12 minutes after the occupant believes it has been extinguished. During this time do not switch off the power or it will reset the 12-minute timer. If the alarm condition has ended, Automist Smartscan Hydra will return to an uncommissioned state and requires service. The customer will contact the Authorised Installer after an activation (see page 99).

In error conditions, pressing the STOP button temporarily silences the error sounds for 12 hours.

In the SYSTEM OK stand-by, pressing and holding the TEST button may be used to enter ALARM TEST MODE. The YELLOW LED will then start flashing – this indicates that ALARM TEST MODE is activated. In this mode you have 15 minutes to press the test button on a wireless alarm, or trigger a wired alarm with heat or smoke, causing the heads paired to said alarm to begin scanning (2 scans will be performed) and flashing red and yellow. ALARM TEST MODE is deactivated by pushing the ENTER or STOP button; this will be confirmed by the GREEN LED returning to constantly lit. Testing the alarms outside of this mode by pushing the button on the wireless alarm will make it beep and the Automist system will do nothing.

GREEN AND YELLOW FLASHING: Indicate an ALARM condition.

RED FLASHING: Indicates a fault where the flashes indicate the error code. In this state the system will also warble and the heads flash red. Please refer to the troubleshooting guide (see page 107). N.B. When Automist Smartscan Hydra is powered up for the first time the YELLOW LED will remain solid to indicate the system has not been commissioned.

SYSTEM OK LED: Lit green when the system is OK and on stand-by.

Commissioning Procedure

Commissioning incorporates four stages:

- 1) **Addresses**, where all the spray heads are bound to the system by linking their internal addresses to the RS 485 communication channel between controller and spray heads.
- 2) **Alarms and zoning**, where the alarms, detectors and spray heads are placed into the different zones they have been specified to protect.
- 3) **Discharge (or flow)** where each spray head is tested to verify it will react as intended when an alarm/detector in its zone is activated. This replicates a response to a fire while allowing for the water to be collected.
- 4) **Drainage**, where the water left in the piping or hoses is expelled through the spray heads to return the system to a dry, stand-by state.

All the information gathered in the commissioning process must be submitted to Plumis in the digital form through the Partner Site so that the location of product serial numbers can be traced, if required, for quality assurance purposes. To collect that information, a manual commissioning form (printable A4 2 pager) from the Partner Site should be used to capture all the key information about your installation (see APPENDIX B on page 116).

When the controller is first powered on, it will be in its **uncommissioned state** - Press and hold the TEST and ENTER buttons for 10 seconds to enter commissioning mode. You can only enter commissioning mode within 60 mins of system power on, this is to avoid unwanted uncommissioning.

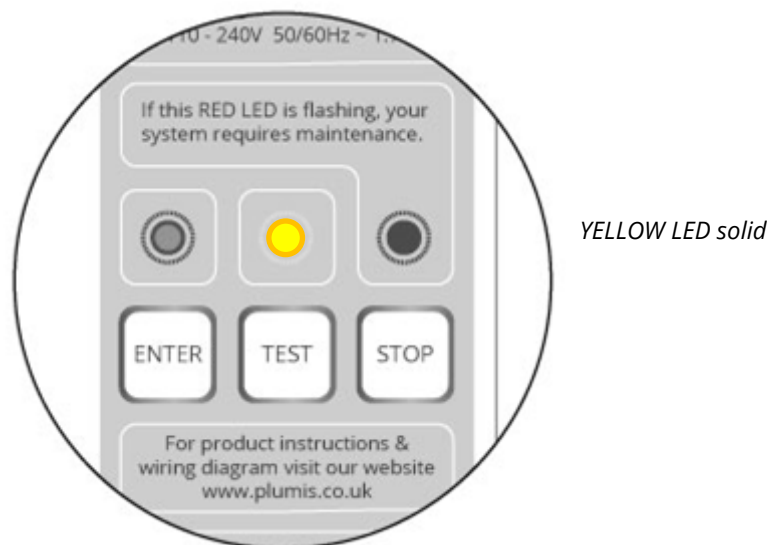

Figure 80: Uncommissioned state

1. Commissioning addresses stage

The single flash of the GREEN LED on the controller indicates commission process one. The number of flashes of the YELLOW LED on the controller indicate the number of addressed heads. Press the spray heads to pair and unpair them, a pulsing yellow spray head is unaddressed, and a solid green head is

addressed. Long press TEST for 10 seconds to clear the commissioning, if required. Press ENTER on the controller to go to the next stage. Short hold STOP to go back to the previous state, if required.

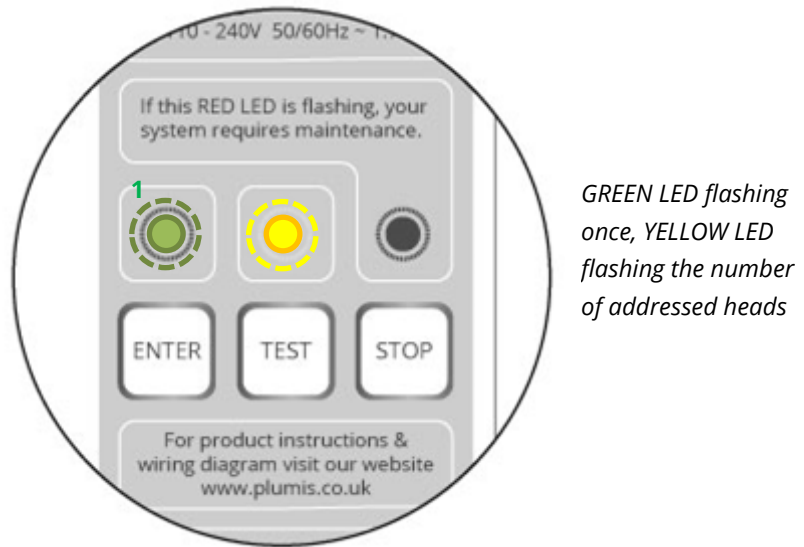

Figure 81: Commissioning mode – commissioning address state

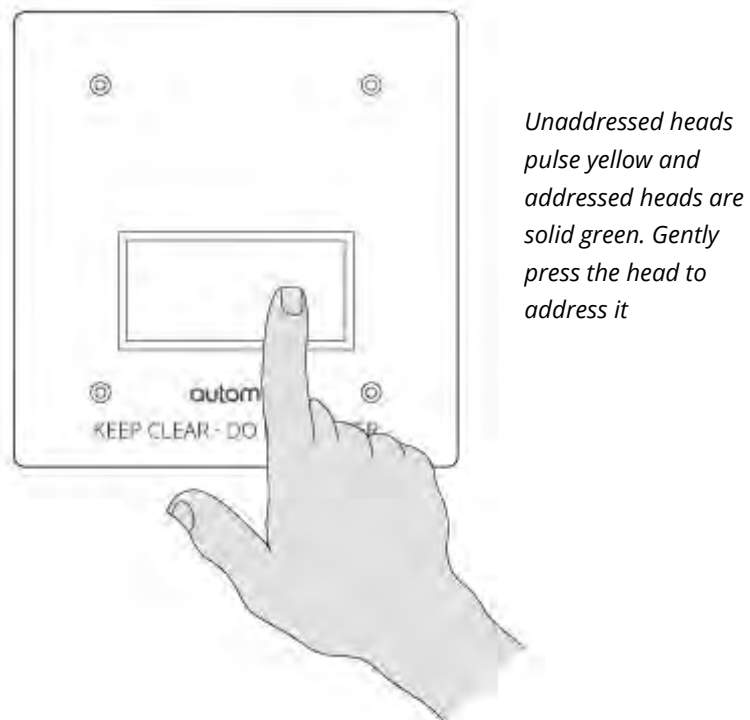

Figure 82: Gently press the outside surface of the spray head with your finger to address it

2. Commissioning alarms and zoning stage

The two flashes of the GREEN LED on the controller indicates commission process two. The spray heads will remain SOLID yellow pending alarm selection. Press the button on a wireless alarm or use a heat gun on a wired alarm to produce an alarm signal. All the unbound spray heads will turn red, while paired spray heads will turn green. Gently press the spray heads to bind and unbind them to the

selected alarm, where the GREEN pulses indicate number of paired heads to the selected alarm. Press TEST to complete commissioning for the selected alarm. Repeat the process for each of the alarms. Press ENTER on the controller to go to the next stage only when all the alarms are paired. Short hold STOP to go back to the previous state, if required.

Note: When pairing spray heads to multiple wired alarm in series, only the alarm at the end of the series must be triggered at alarm commissioning state. But the rest of the alarm(s) in this series must be tested with “Alarm Test Mode” after commissioning.

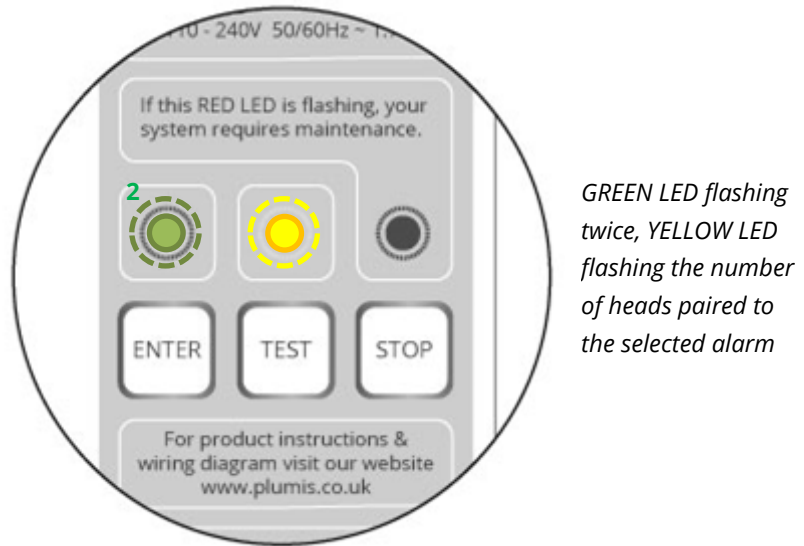

Figure 83: Commissioning mode – commissioning alarm state

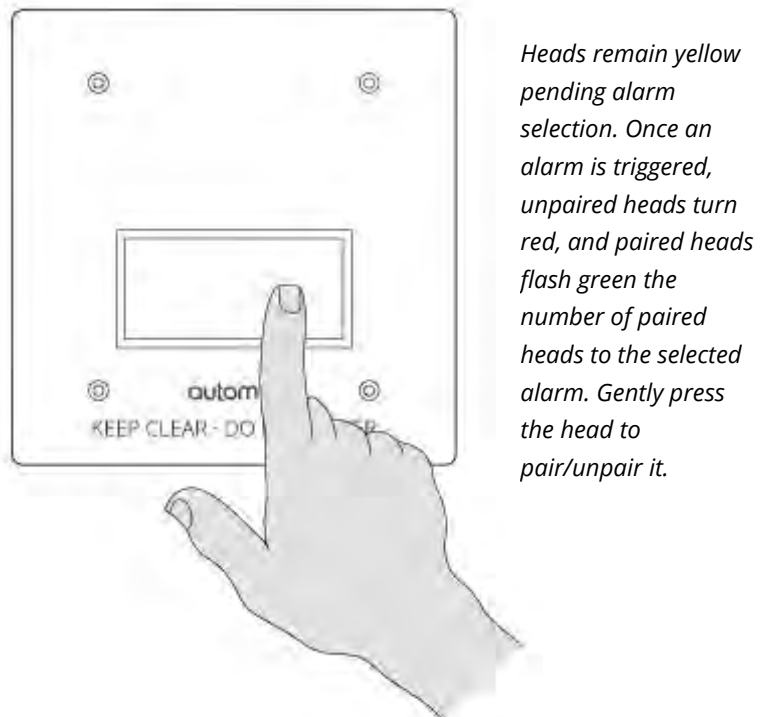

Figure 84: Gently press the outside surface of the spray head with your finger to pair it

3. Commissioning discharge stage

The three flashes of the GREEN LED on the controller indicates commission process three.

IMPORTANT! Always select the lowest spray head and nearest to the pump first for flow testing first before progressively moving higher and further away from the pump. This considers the most effective way to drain the hoses.

IMPORTANT! During flow test and draining process, small amount of water will possibly come out of the drain hole on top of the spray head's main body block (drain hole not visible as obstructed by servo motor shaft). Check all spray heads during each flow test or draining step. Dry the parts if water is visible.

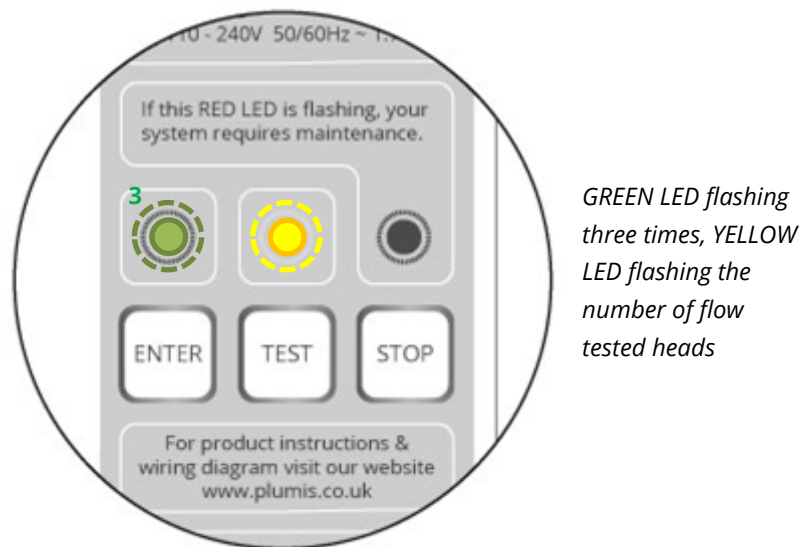

Figure 85: Commissioning mode – commissioning flow state

The spray heads will glow red and lock pending head selection. Press the first spray head and initiate a scan test. The head will scan once and point to the warmest position that it observes which must be your hand. It will then rest in an approximately 90-degree position and turn solid yellow if scan test was successful. If unsuccessful, the head will remain solid red and return to the locked position. Gently push the head to retry the scan test. If it still fails, turn off the system, and visibly check the sensor is clean of any dust or water. The sensor must see a temperature difference during the scan for the test to pass.

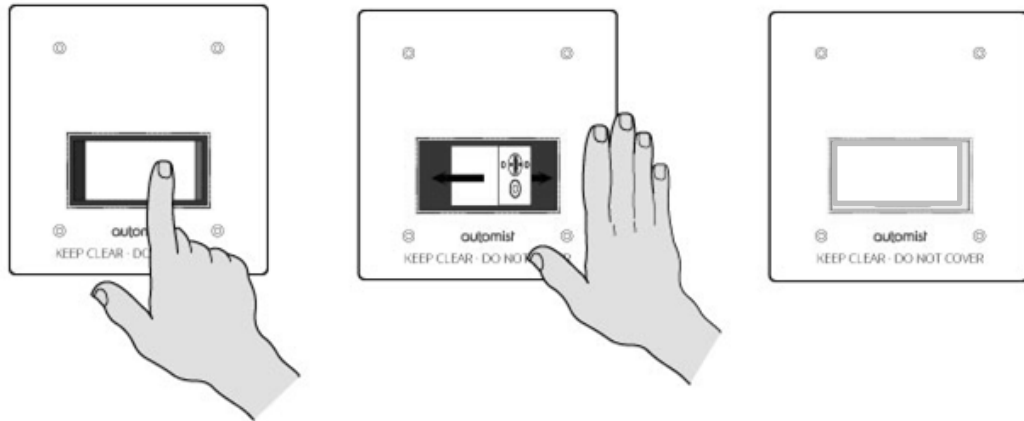
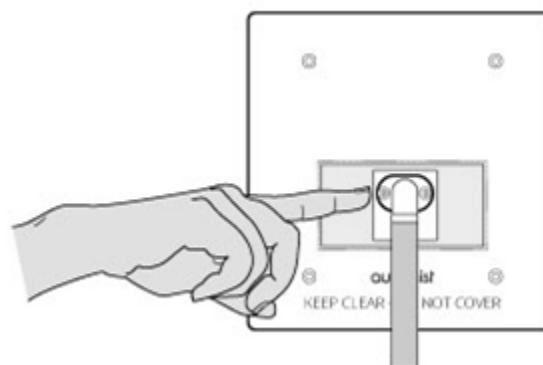

Figure 86: Testing the IR sensor and selecting the head for flow testing

Unscrew the cap on the quick connect test point (see page 79) and connect the test hose and gauge to the test point adapter. Connect the commissioning kit (CM06) to the selected spray head and place a bucket or container with over 6 litres capacity on the floor to collect the water. Ensure the volume of water reaches the approximate 6lt level mark in the bucket.

The next step of commission is testing the discharge. Gently push the head 45 degrees to initiate flow test. The head will begin to flash yellow to indicate water is about to flow, during this period the head may be pressed again to cancel. Once the pump is activated, the head will light blue. At this point the pump can be stopped by pushing the head again, by 45 degrees, until water starts to flow, at which point the spray head will lock. The pump can only be stopped then by pressing the STOP button on the controller.



Yellow flashing means water flow is coming. Solid blue means water is flowing. Solid green means successful flow test complete.

Figure 87: Attach flow test tool and gentle push the head 45 degrees to initiate or stop the flow test.

Once the discharge test is successfully complete the spray head will turn solid green. Check the gauge at the pump during the flow and ensure that the output pressure has reached a stable 80 to 110 bar.

Note: the system has one second pause after 10 seconds and 30 seconds from activation of pump as a safety feature. Read and record the pressure after the second pause.

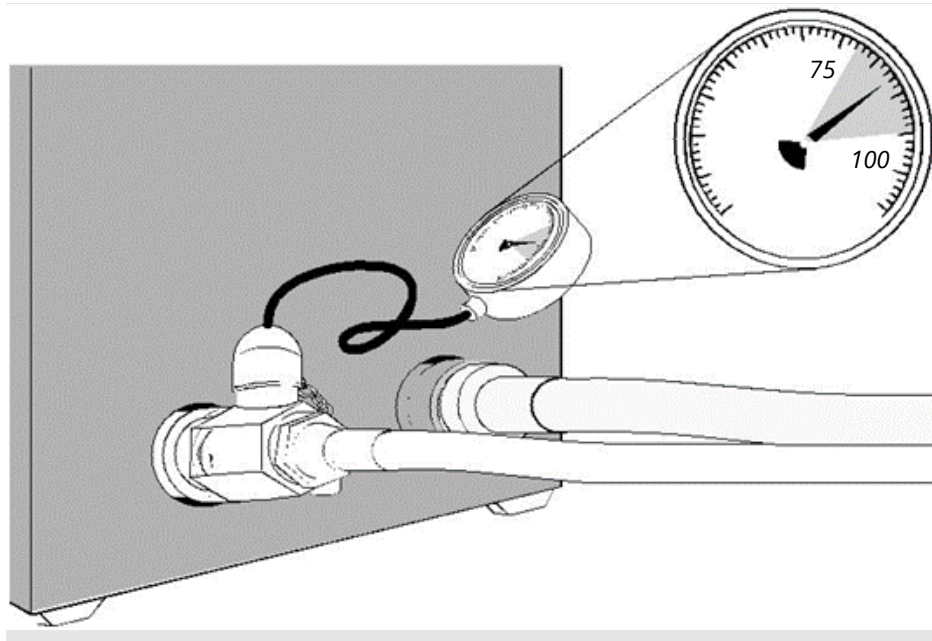

Figure 88: The pressure gauge during commissioning.

IMPORTANT! The pump features a cut-out which will disable it if the pressure becomes excessive, so it is critically important not to leave an installed system with a high out-of-spec pressure. By leaving an installed system with pressures outside the specified range, you might become liable for deaths or injuries. If the achieved output pressure is outside the specified range, refer to the commissioning troubleshooting guide (see page 107) and contact Plumis if the situation cannot be resolved.

IMPORTANT! Check and record that there are no leaks behind the head, at the pump or along the hoses.

IMPORTANT! A very small amount of water underneath the pump after commissioning is acceptable. This leak comes from the pump gasket only when the pump is first switched on after a long storage period. In this case, dry the pump base and wait for 5 minutes. Verify that there is no more leak coming from the pump when the pump is off.

IMPORTANT! The commissioning tool must be removed as soon as water has stopped flowing into the bucket, otherwise, the spray head cannot return to its parked position.

IMPORTANT! Wipe the head IR sensor dry with a dry cloth, to ensure that there is no water left on the IR sensor.

IMPORTANT! With the commissioning tool disconnected, gently push the head 45 degrees to complete the flow commissioning and lock the head.

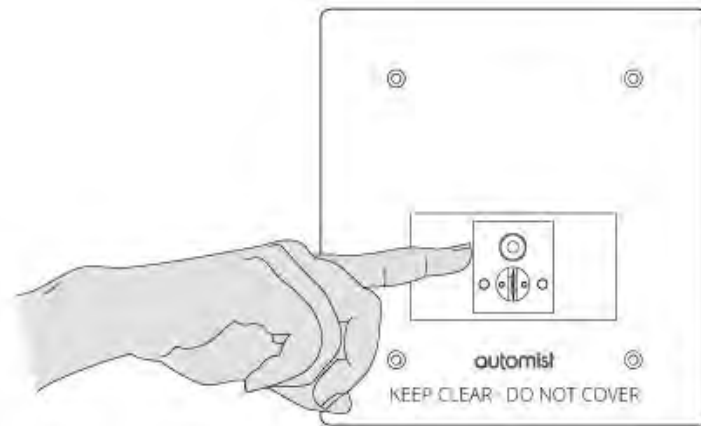

Flow tested and locked head will glow green.

Figure 89: Remove flow test kit and gently tap to close head and lock

IMPORTANT! Repeat the process for every spray head. Always select the lowest spray head and nearest to the pump first for flow testing first before progressively moving higher and further away from the pump. This order considers the most effective way to drain the hoses. Once all the heads in the system have been flow tested and are glowing green. Press ENTER on the controller to go to the next stage only when all the heads are flow tested. Short hold STOP to go back to the previous state, if required.

4. Drainage stage

The four flashes of the GREEN LED on the controller indicates commission process four. Remove the quick connect test point with the pin and allow any remaining water to be drained into a bucket. During this state all the spray heads flash rainbow colours and are locked, they can be selected individually to connect a commissioning tool if additional water needs to be pumped out. The high-pressure hose must be cleared of water by connecting a bicycle pump or a suitable compressor pump (see *Figure 77*) to the Plumis supplied attachment that is connected to the test point.

IMPORTANT! The high-pressure hose must be cleared of water by connecting a bicycle pump or an air compressor pump with a maximum pressure of 8 bar for draining of water. Start with the head that is highest and furthest from the pump and work your way back to the pump decreasing in height, and ensuring you open every head in the system.

IMPORTANT! Leaving water in high pressure hoses following the commissioning/servicing process can lead to dripping nozzles, particularly if any part of the hose passes above the nozzles. To prevent this, the water must be expelled after commissioning.

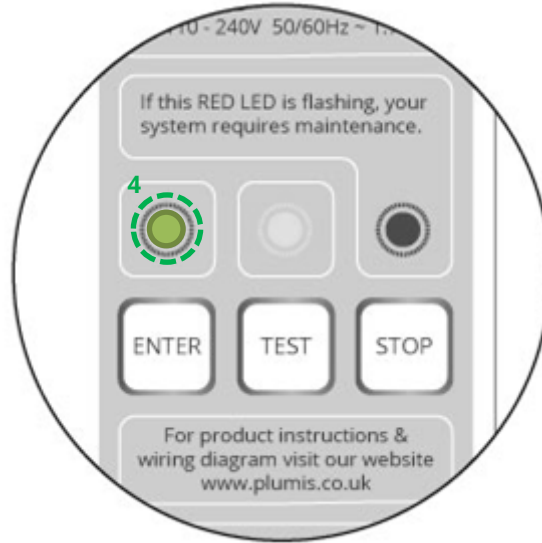

GREEN LED flashing four times

Figure 90: Commissioning mode – commissioning pipes state

Short hold STOP to go back to the previous state, if required. Press ENTER on the controller to complete the commissioning process, which will turn the GREEN LED solid, indicating the system is its OK state.

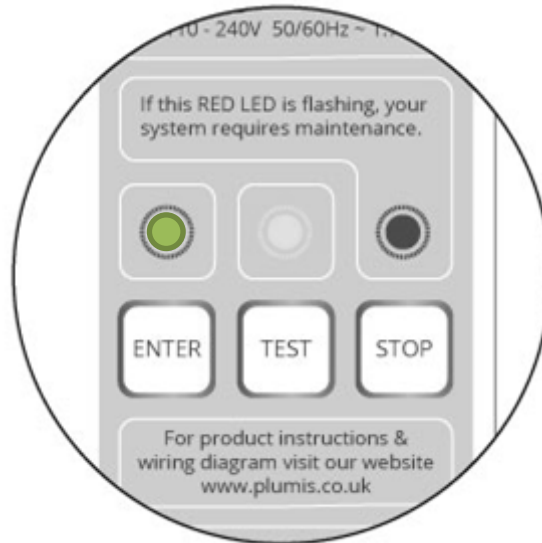

GREEN LED solid

Figure 91: System ok

Slide the heads into the rectangular hole (89+/-2mm wide x 117 mm high) and fasten in place using the foldable brackets (SK11) provided. The brackets lock the spray head tightly to wall plaster, dry wall of any thickness up to 3/4", concrete block, brick or concrete wall.

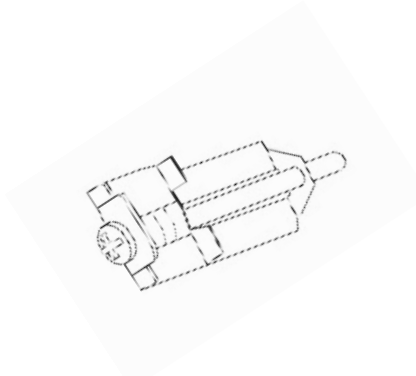

Figure 92: Foldable Bracket

Attach and fasten the front plate to the intermediate plate and align, ensuring parallelism to floor and wall. You can align the Front Plate in reference to the floor.

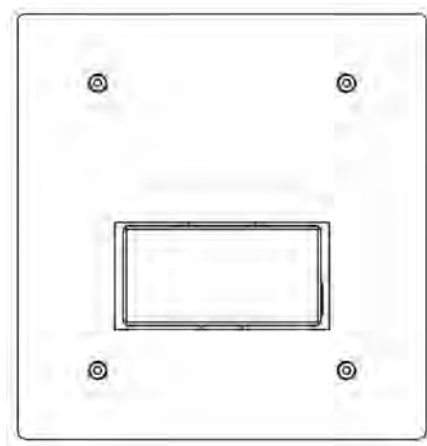

Figure 93: Front plate

Please ensure there is good clearance around the rotating head and the front plate. It is recommended to perform a final alarm test mode (see page 94) to ensure the heads has the freedom to rotate.

Online logbook

Once you have successfully commissioned your unit, complete the online commissioning form, and attach a layout diagram and optional photos. A log of all the key information is stored in the Plumis installation database.

Warning Labels

Place the two warning stickers and the commissioning label:

- Label the separate circuit on the distribution board
- Label the alarm that triggers Automist Smartscan Hydra, preferably near the test button
- Complete the installer commissioning label and affix to your Automist Smartscan Hydra pump.

IMPORTANT! Record the output pressure from the commissioning gauge on the Installer Label (as shown on Figure 94) and keep a record of the details for inputting into the online commissioning form.

**AUTOMIST FIRE
PROTECTION POWER SUPPLY
DO NOT SWITCH OFF!**

**THIS ALARM WILL
ACTIVATE AUTOMIST**

Cold water inlet only

Installer _____ Installation date _____

Installation Company _____

Person/s responsible for maintenance _____

Contact details of person/s responsible for maintenance _____

Maintenance is required _____ Annually / Biannually _____

Date	Pressure	Date	Pressure	Date	Pressure

All installations must be registered - www.plumis.com

Figure 94: Labels

IMPORTANT! Fill out the user instructions one pager and leave for the homeowner in an appropriate place. Also available for download on the partner page. An additional user instructions is available in Appendix D for residential installations (see page 121)

About your Automist Smartscan System

In the event of a large fire, Automist will spray a fine mist of water. It is set off by a multi-criteria alarm, so won't go off due to just smoke.

If it does go off and you need to stop it, there is a **STOP button** on the controller.

DONT put objects in the way of the spray nozzles. Automist will only operate at its maximum effectiveness when spray heads are kept clear.

And in the event of a serious fire, **DO leave the property and call 999**

If the **RED LED** on the controller, or the heads are **flashing RED**, your system requires maintenance. Contact your Accredited Automist Installer.

Do not attempt to repair your Automist system. Doing so will invalidate your warranty (details on your Automist warranty certificate).

The pump is located	
The controller and therefore the STOP button is located	
If the Automist system is making sounds, flashing red, or leaking water, call	

Registration

Register your Automist fire sprinkler online at www.plumis.co.uk/register

- Ensure you can take full advantage of the manufacturer's warranty
- For Product update or essential bulletins
- Learn key information about how your system works
- Optional maintenance reminders to ensure your life safety system is working

Waste electrical products should not be disposed of with household waste. Please contact the organisation who provided Automist for recycling/disposal advice as regional variations apply.

Plumis

Figure 95: User Instructions

Re-enter Commissioning Mode After Successful Commissioning

The system will be locked one hour after it is successfully commissioned. To re-enter the commissioning mode in the locked status, please power cycle the system and then long hold "ENTER" & "STOP" buttons for up to one minute.

Alarm Test Mode

Once the system is commissioned ALARM TEST MODE allows you to test the alarms in the home without activating Automist Smartscan Hydra, by causing the paired heads to begin scanning. Alarm testing is a normal part of detector maintenance as part of the manufacturer's guidelines. If the detector is a combination heat and smoke alarm both elements must be tested independently with a heat gun and then a smoke detector tester aerosol:

- In the SYSTEM OK stand-by, pressing and holding the TEST button may be used to enter ALARM TEST MODE. The YELLOW LED will then start flashing – this indicates that ALARM TEST MODE is activated.

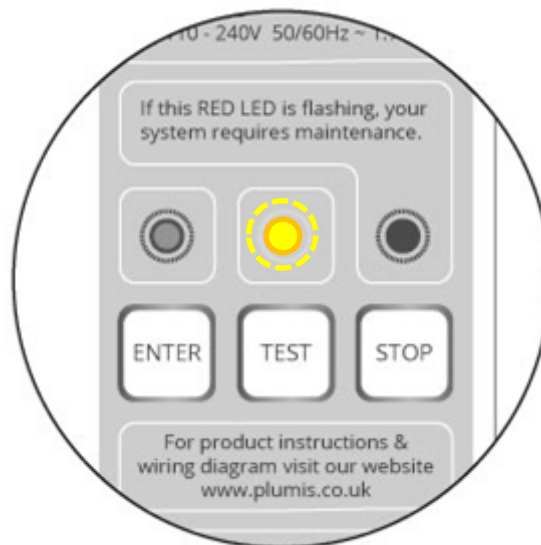

YELLOW LED flashing

Figure 96: ALARM TEST MODE

- In this mode you have a short time (15 minutes) to test the alarms either by pressing the alarm's test button, or with a smoke gun, or a heat gun. All paired heads flash yellow then red and scan, non-paired heads flash yellow then red but remain closed
- ALARM TEST MODE is deactivated by pushing the ENTER or STOP button; this will be confirmed by the GREEN LED returning to constantly lit.

Compliance Certificate

On satisfactory completion of the commissioning by the Automist Installer, a commissioning certificate should be issued, which attests that Automist has been designed, installed, and commissioned in accordance with this DIOM. Any variations from this DIOM should be agreed with the AHJ and should be clearly stated on the compliance certificate.

Documentation

All layout drawings and documents should include, as a minimum, details of the system which should include:

- a) the address and location of the premises;
- b) the name and address of the Automist Installer;
- c) the name of the Automist Designer; and
- d) the date of installation.
- e) the list of the equipment used in the installation

In accordance with BS 8458:2015 7.3.2, the following information should be provided to the owner or occupier:

- a) *'details of the authorities consulted and any response to consultation;*
- b) *a general description of the system including water supply details, and a statement of compliance with this DIOM in the form of a signed compliance certificate (an installer's declaration of conformity, i.e. a claim by or on behalf of the installer that the product meets the recommendations of this DIOM. The accuracy of the claim is solely the claimant's responsibility), together with any variations agreed with the AHJ and justification for the variation;*
- c) *a layout drawing of the premises, which includes "as fitted" details showing the extent of the installation;*
- d) *details of the water supplies which, if a mains water supply, should include pressure and flow rate data at a specified location for the commissioned installation, with the time and date of the test;*
- e) *information about the configuration of the alarm device and whether it is connected to an alarm receiving centre;*
- f) *a 24 h emergency telephone number which can be used to obtain assistance if applicable;'*

Post-installation checklist – Key points for installers and Building Control

IMPORTANT! It is the Automist Designer's responsibility to ensure when using the product as part of a fire strategy or for code compliance to ensure the system is installed as per the guidelines (see page 26). The layout drawing must reflect the as-fitted installation layout.

Power supply

- The Automist Smartscan Hydra circuit must be clearly labelled (a label is provided for this purpose).
- Power to Automist Smartscan Hydra must be provided via an unswitched fused connection unit (FCU).
- Automist Smartscan Hydra must be supplied using FP200 cable or better, ideally inside conduit or protected 50mm deep within a wall
- Automist Smartscan Hydra may be protected by an RCD or RCBO, but this protection must not be shared with other circuits. Therefore, Automist Smartscan Hydra must be connected to the non-protected side of the consumer unit.
- The circuit supplying a single Automist Smartscan Hydra unit would commonly be protected by a type 'C10' or 'C16' MCB, for example, or 'C20' / 'C32' for two Automist Smartscan Hydra units.
- Metal consumer units complying with 18th Edition IET Wiring Regulations to BS 7671 2018; do not require the addition of an over box to meet BS476 Part 22 (1987) and EN1364 (1999).

Water Supply

- Check valve and filter must be installed to ensure back flow protection to the mains water and debris into the pump (supplied in kit).
- A PRV must be fitted according to Figure 2 for water hammer / over pressure protection.
- Inlet water must be connected, and the valve left open.
- WRAS approved isolation valves are required so that the Automist Smartscan Hydra system can be shut off from the water main. All such valves must be labelled with the included supply warning labels.
- Priority valves are not normally required but must be used in circumstances where the water supply may otherwise be inadequate.
- Ensure the property has a water supply sufficient for the system operation in a worst-case scenario.

Pump & spray head placement

- All Automist Smartscan Hydra units must have been successfully commissioned using detectors, with both thermal scan and outlet pressure verified.
- Minimum ventilation requirements met (0.124m³)
- In a room or cupboard that is separated by a fire resisting partition from the mist-protected room(s) that it serves, or the pump located such that it is: a) unlikely to be affected by a fire b) protected in the event of fire; c) unlikely to be affected by flooding.
- All Automist Smartscan Hydra controllers must show "System OK" (green LED), indicating it has been successfully commissioned.
- The maximum allowable total data cable length from the pump to the furthest spray head in the daisy chain is 60m.
- The maximum allowable total data cable length for the pump to the controller is 30m.

Head Placement

- Between 1.20 and 1.45m high for spray head in non-kitchen area.

- Between 1.10 and 1.45m high for spray head in kitchen area.
- In a “preferred position” and clear from obstructions (1.5m around the head).
- Head placement matches the as built layout drawing supplied with the commissioning form.
- The coverage must be in line with Plumis Guidelines and the guidance in this DIOM. Any deviations must be justified by the Designer and agreed in written with the AHJ.

High Pressure Hose

- High pressure hose must have been flushed with air to remove water, avoid dripping and Legionella.
- High pressure hose must be protected by a fire resisting barrier, and a fire resisting sleeve if exposed.
- It is critically important that the high-pressure hose locking pin (behind the pump) is in position so that the quick connector and O-ring are firmly retained after any operations that required disconnection of the high-pressure line.
- High pressure hose must not exceed the minimum bend radius

Stainless Steel Piping (alternative to high pressure hose)

- Material: Stainless Steel
- Stainless steel pipes and fittings must conform to
UK (BS 8458:2015): ASTM A269-10 and ASTM A312
US (NFPA 750): ASTM A269 or ASTM A 632 or ASTM A 778 or ASTM A 789/ A 789M
- Internal diameter: 5/16” (8 mm)
- Working pressure at least: 150 bar
- Maximum total length: 50m

Fire Stopping

- Ensure any connections between fire-separating elements are fire-stopped to maintain the continuity of resistance.

Coverage

- **IMPORTANT!** It is the designer’s responsibility to ensure when using the product as part of a fire strategy or for code compliance to ensure the system is installed as per the guidelines (see page 26).
- If protecting the means of escape only, ensure all adjacent rooms which are not separated by a fire resisting door are covered. Covering only the stairs will not suppress fires in non-separated adjacent rooms, negatively impacting tenability on the escape route.

Documentation

- Installer sign-off details (including pump pressure) are noted on pump.
- An occupant information sheet must have been provided to the property.
- The Installer Commissioning form must have been provided (can be obtained from Plumis or the installer) with a matching layout drawing.
- The Plumis Warranty Certificate is provided (can be obtained from Plumis) once the layout has been submitted and approved by Plumis.
- It may be useful to take photos of any safety critical elements for your own records.

OPERATION

What to do if the system activates?

Once the system is activated, it will remain beeping whilst the pump is running.

To stop it, you can either:

1. Wait until the pump has run continuously for 30 minutes. It will then exit to Idle mode (uncommissioned).
2. Press the stop button and the pump will stop discharging but the system will remain beeping for 12 minutes. During the first 2 minutes, the pump will not discharge again, but between the end of the second minute and the end of the 12th minutes (therefore during the last 10 minutes), if a detector is activated again the pump will restart and will discharge mist at the same direction it first discharged. This mode was created to address the fire returning after an occupant believes it has been extinguished, at which point they stop the pump discharge and exit the property. When in this mode, do not switch off the power or it will reset the 12-minute timer. If the alarm condition has ended, Automist Smartscan Hydra will return to an uncommissioned state and requires full recommissioning.

Please be patient and wait for the 12 minutes to end before trying to recommission the system.

IMPORTANT! Reporting fires which have been controlled or extinguished fires, false positives or false negatives is useful for Plumis for continuous improvement. Please contact Plumis (technical@plumis.co.uk). Further information can be gathered from the system as Automist has a "blackbox" (like aircrafts) that logs all the product's activity and input from sensors to validate that it was a growing fire that was tackled.

MAINTENANCE

Maintenance

For external parties, for example the responsible person, homeowner, or warden:

1. Visual inspection

IMPORTANT! A visual inspection of the spray heads must be performed at a rate, equal to, or greater than, the frequency of any alarm testing already in place (e.g. at least weekly in residential care). If there is no alarm testing in place a 'reasonably practicable' inspection rate should be chosen (see page 20 for reasons why you might want to consider implementing, at least, a weekly routine).

- Ensure that each head is clear from obstructions (1.5m on each side) and advise the occupant that if this area is not kept clear of obstructions over 0.9m high it may hinder the operation of their fire safety system.



Figure 97: Keep clear of obstructions zone (min. 1.5m)

- Check no fault signals are present. A red flashing LED on the controller and warbling, a red flashing head or a flashing and beeping detector indicates an error condition (see page 96). Contact your nearest Authorised Reseller Installer to address the fault.
- Verify that the layout has not changed from the original drawing. If it has, contact the Authorised Reseller Installer, as your system may require an upgrade.
- Verify that the hazard has not changed from the original requirements specification.
- Verify that the system has not been modified by comparing it to the provided Compliance Documentation.
- Verify that the system filters/strainers are unimpeded. They should be cleaned or replaced if necessary.
- It is recommended that the homeowner test the alarm in ALARM TEST MODE (see page 94) once a week. This mode allows you to test the alarms causing the paired heads to begin scanning.

2. Service the detectors/alarms

IMPORTANT! Detectors and alarms must be serviced at least annually. If in doubt, follow the manufacturer's instructions.

- Change the battery on any wireless alarms.

To replace the batteries:

- Remove the alarm from its mounting base by twisting the alarm counter clockwise. Remove and dispose of the batteries according to your local regulations.
- To ensure proper power-down sequence, wait a minimum of 20 seconds before installing new batteries.
- Install 3 new AAA batteries (available from your local Duracell or Energizer dealer) in the battery compartment. Follow the polarity diagram inside the compartment. If the batteries

are incorrectly inserted, please remove gently with a non-conductive tool, and correctly reinsert

- d. Reinstall the alarm onto the mounting base by turning the detector clockwise until the mating marks align.
 - e. After the power-up sequence the green LED must blink about once every 12 seconds to indicate normal operation. If the batteries are not installed correctly, the alarm will not operate, and the batteries may be damaged. If the detector does not power-up, check for correct batteries installation and for a fully charged batteries. Please refer to the Apollo flash codes for more details.
- **IMPORTANT!** – only use batteries specified. Use of different batteries may have a detrimental effect on the detector. The wireless detector should be powered by a 3 AAA Duracell Procell or 3 AAA Energizer E92 batteries. The detectors flash yellow every 12 seconds for a low battery warning. Be sure to replace the batteries with new ones at each annual servicing regardless of if they are low or not.
 - Any remote monitoring arrangements should be tested to determine whether they are being transmitted and received correctly.

For the Authorised reseller Installer:

3. Authorised Reseller Installer inspection

IMPORTANT! A system inspection should be performed at least Annually.

- Carry out a visual inspection as detailed above. It is recommended you take pictures of each head for your records. If you find any head has been obstructed, issue the customer with a non-compliance notice (on page 114), offer them a solution (relocating or adding an additional head) and inform Plumis. This feedback helps Plumis keep our preferred positions principals are in line with how people use their homes and can improve our recommendations for the future.
- Verify that there is no discolouration of the filter element.
- If a prepay meter is present specifically for Automist (see page 61) top it up with credit to a level beyond its expected lifetime usage or advise the responsible person.
- Determine whether any modifications have been carried out and the Design Specification is still valid. If there has been a material alteration to the building, an increase in fire loading or a change to include vulnerable occupants, an assessment should be made as to whether the category of system is still appropriate.
- Any mains boost water tanks should be checked to see they are functionally correctly and have been maintained as stipulated in their manufacturer's instructions.
- Inspect the heads and the low-pressure connection for any sign of leaks. If there are any signs of leaking following the troubleshooting guide to find the fault (see page 107).
- It is also worthwhile to reissue a user guide (page 121).

4. Software update process

IMPORTANT! The software must be updated annually.

- Complete a full software update (see Software update process on page 104).

5. Recommissioning

IMPORTANT! A full recommissioning (page 81) must be performed at least annually as part of the maintenance process, as a result of building works or after an activation. It may not be 'reasonably practicable' to test every head in a system in very large building, therefore as a minimum test only one head per system. Selecting a different head each time. Ensure that water, and subsequently air, is pump out from every spray head to ensure that the system is returned to a dry state and to verify whether there are any blockages. Once, finished, unlock the locking pin, and remove the quick connect test point from the pump. Pour out any stagnant water into a bucket. If this is more than a pint, please take a photo and contact Plumis. Dry the high-pressure outlet of the pump and wait 2 minutes to confirm no water is flowing through the pump before reconnecting the high pressure hose, quick connect and locking pin. If water persists to flow through the pump see trouble shooting section.

IMPORTANT! Every 5 years additional maintenance must be carried out before starting the normal procedure (above):

Replace the consumables

- Replace the washers in the low-pressure hoses
- Replace the filter with a new one

Inspection and testing of hoses and pipework and Automist

- After 20 years all pipework, hoses and Automist should be inspected. The pipework should be thoroughly flushed out and hydrostatically tested. All pipework and hoses should be externally inspected. At least one metre length of pipe should be inspected per 50 systems. Two sections of at least one metre length of each pipe or hose diameter should be inspected. All defects which might adversely affect the performance of the system should be eliminated.
- 3% of the units in a building or scheme, whichever number is the largest, should be removed, labelled with location in the building, and sent to Plumis for testing. The selection and removal of components should be taken from a variety of locations that are representative of the range of environmental conditions that they have been subject to in service. Removed systems should be replaced with systems appropriate to the system's Design Specification.
- The system will be evaluated by Plumis for the following:
 1. Inspection and quality assurance checks of the spray head, pump and controller;
 2. Where failures of in-service equipment are noted in these tests, it might be necessary to conduct further investigation or replace components representative of the batch tested.

Software update process

IMPORTANT! Updating the software is required as part of the maintenance of the system and can only be performed by an Authorised Reseller Installer. Switch off electricity at the mains before working on existing circuits. Take care not to touch the PCB.

The latest version of the software is uploaded to the datalogger once a year by Plumis.

Use the system as-fitted layout to locate the controller within the customer's house. Check that only the controller green LED is lit, showing the controller is powered with no errors. Unscrew fastening screws with a small Philips head screwdriver. Be careful with the screws as they will be needed for reassembly. Expose the controller PCB by lifting the lid up and to the side. Be careful not to extend the flexible keypad's ribbon, which is connected to the PCB, when lifting the lid, as shown in the figure below.

The PCB has three areas of interest on the board:

- A) Software LED. This will be illuminated and flickering when software is running on the board.
- B) Power LED to indicate the board is powered.
- C) 6pin needle programming port. We will be connecting to this to reprogram.

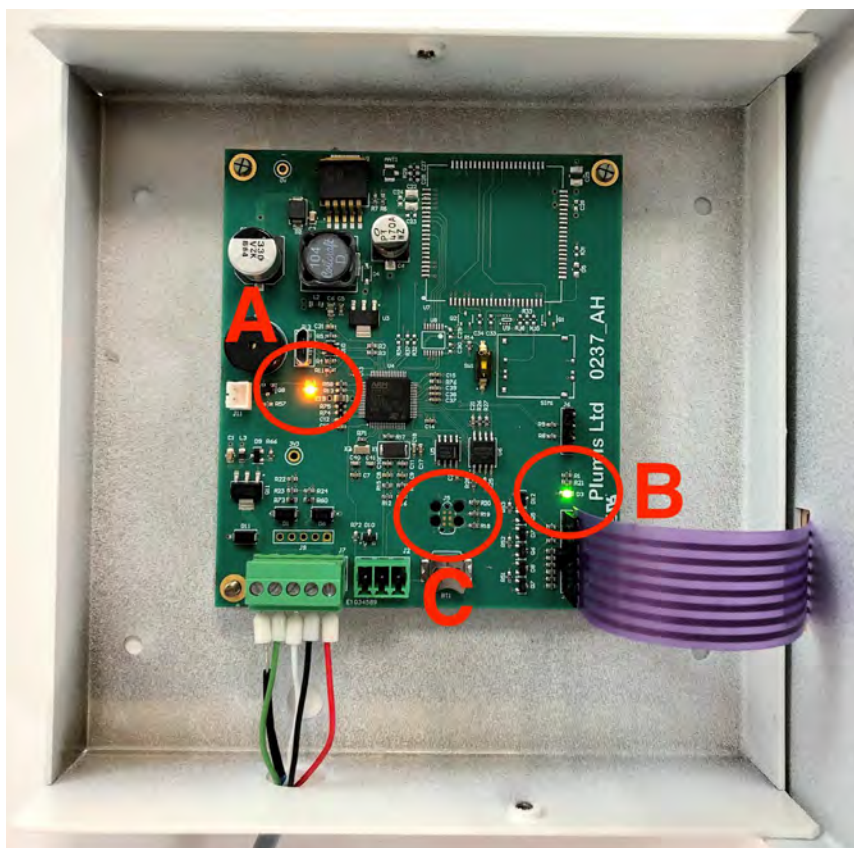

Figure 98: Inside the controller

Setup the Flasher

Remove the flasher and 6pin needle adapter from the kit box. Insert the 6pin needle adapter into the Flasher. Turn on the Flasher by pressing the power button, it will now display "Ready".

IMPORTANT! The flasher may turn off due to an extended idle period. Simply press the power button to turn back on.

Programming

Press the 6pin needle adapter into the controller PCB programming port (C). The four support legs may need to be pinched in as the adapter is pressed into the PCB. When fully inserted the needle adapter will be locked to the PCB.

The controller software is now ready to be updated. If necessary, turn the flasher on, then press the 'PROG' button on the Flasher. Watch the Flasher display, it will say "Erasing", then "Programming", and finally "OK". Note: If the red "ERROR" is displayed, please check your connection, and retry. If it persists, contact Plumis for advice. Note: The Hydra heads will lock and start flashing red x4. The heads will remain like this until the controller is reset.

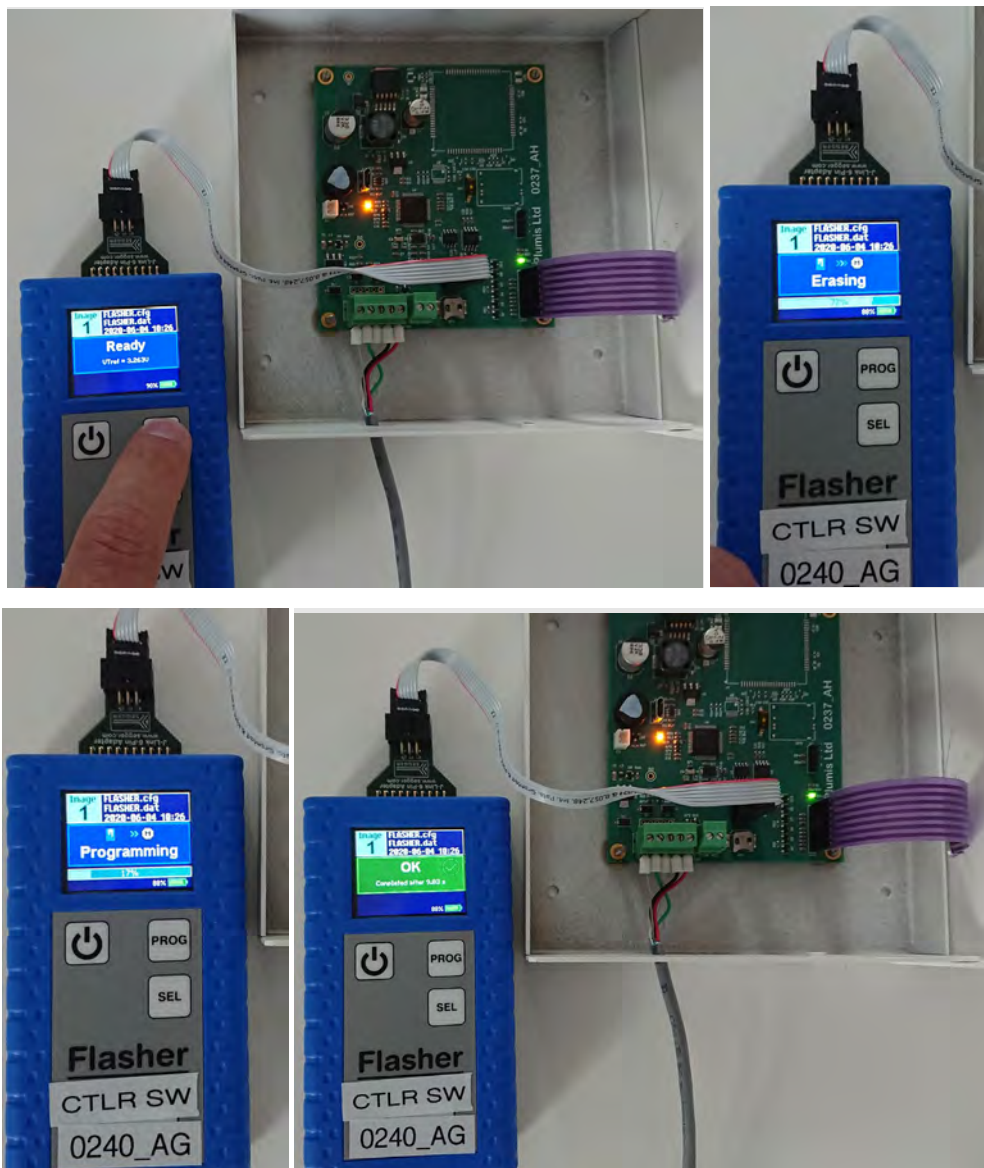

Figure 99: Updating the software

Disconnect the needle adapter from the PCB by pinching the legs in and pulling upwards. The controller requires a power cycle to start running the newly programmed software. To do this disconnect the Power/Data connector in the bottom right of the board, then reconnect. The Controller will sound a start-up chime, and the Hydra heads will return to the parked position. Close the lid of the controller. Screw in the top and bottom lid fastening screws. There is no need to commission the system after a software update unless commissioning is required (see page 81).

Cleaning

The Automist Smartscan Hydra wall-mounted head must be wiped clean with a damp cloth. Do not attempt to clean with any other chemical cleaners or abrasives

To clean the alarm or detector, remove it from the mounting base. N.B. This will trigger a tamper error on the controller. You can clean the interior of the alarm by using compressed air or a vacuum cleaner hose and blowing or vacuuming through the openings around the perimeter of the detector. The outside of the detector can be wiped with a damp cloth.

After cleaning reinstall and test your alarm by using. If cleaning does not restore the alarm to normal operation the alarm must be replaced.

Repair

CAUTION! Do not attempt to repair the Automist Smartscan Hydra head, controller, or pump unit. Doing so will invalidate your warranty.

Automist Smartscan Hydra must be serviced or replaced if any part of the system, including any heat alarms, has been exposed to fire conditions.

Troubleshooting

Problem	Probable Cause	Recommended Action
Pressure does not consistently reach correct range (too low) during commissioning procedure	Leakage between pump and Automist Smartscan Hydra head	<p>Check for leakage on the high-pressure hoses/piping, for example the quick-fit connector may not be secured, or its O-ring may not have been fitted.</p> <p>Re-run commissioning.</p>
	Blockage at the pump inlet	<p>Close off the water with the isolation valve.</p> <p>Disconnect the hose at the pump inlet and check for blockages on the pump strainer and within the inlet hose.</p>
	Mains pressure or flow is too low	<p>Close off the water with the isolation valve and disconnect the hose.</p> <p>Verify that the water mains connection can supply at least 8 litres per minute (lpm) of flow and check that the static inlet pressure is at least 1.5 bar.</p> <p>If the flow is close to or below 8 lpm, the mains pressure may be too low for Automist Smartscan Hydra to operate correctly, or there may be constrictions in the water supply. A plumber must be called to resolve the issue.</p>
	Pump not providing enough flow	<p>Re-run the commissioning procedure with the high-pressure hose outlet placed inside a container with volume markings of at least 6 litres.</p> <p>If the volume of water is less than 5.6 litres after the commissioning discharge of one head, there may be an inadequate water supply or a damaged pump. Please contact Plumis technical support.</p>

<p>Controller persistently produces a warbling sound and shows a red LED flashing. The head will also flash the error code.</p>	<p>Pump not yet commissioned</p> <p>Incorrect wiring to pump, controller, or spray head</p> <p>Pump or spray head damaged in transit</p>	<p>The number of beeps (or trills) and flashes that the controller sounds when in fault mode is intended as a diagnostic. Please count the beeps:</p> <p>One beep (Head jammed) - Remove the head from the wall with the connections remaining. Ensuring no items are jamming the head. Turn off and on the system. If the error condition remains, follow the returns procedure (see page 111)</p> <p>Two beeps (Temperature Sensor Error) - Turn off the system. Gently clean the sensor with a clean cloth to ensure there is no dirt on the glass. Power on the system. If the error condition remains, follow the returns procedure (see page 111).</p> <p>Three beeps (Wiring fault (Controller & Pump)) - Turn off the system. Ensure the connections between the pump and the controller are the right sequence. Ensure the cable is not damaged. Important! Ensure the mains is off when disconnecting and making connections. Turn on the system. If the error condition remains, follow the four beep procedure.</p> <p>Four beeps (Wiring fault (Pump & Heads)) - Turn off the system. Inspect the wiring and check the continuity of the connections to the head. Power on to verify the error message is no longer present. Important! Ensure the mains is off when disconnecting and making connections. If the error condition remains, follow the returns procedure (see page 111). This error can also be caused by removing a head or moving a commissioned head from another system into this one, outside of the commissioning process.</p> <p>Five beeps (Factory Fault) - Contact Plumis.</p> <p>Six beeps (Wireless alarm not broadcasting) - Verify the detector is powered and in a normal state (Green flash every 12 seconds). If the detector is off, you may need to change the batteries. If the error is still present your detector may be out of range from the head(s). Remove the detector and move closer to the head(s). If the error condition remains, follow the returns procedure (see page 111).</p> <p>Seven beeps (Alarm Fault) - This indicates an alarm fault. If it is a wired alarm, you have a wiring problem (open or short circuit), please examine the connections. Also verify that you have added a correctly wired resistor to the connection end</p>
---	--	---

Problem	Probable Cause	Recommended Action
		<p>(see page 61). For a wireless alarm please refer to the alarm failure modes in the next row.</p> <p>Eight beeps (Wireless tamper alarm) – Verify that the wireless alarms are in their bracket.</p> <p>Nine beeps (Factory Fault) - Turn off the system. Wait for 2 minutes. Power on the system. If the error condition remains, follow the returns procedure (see page 111).</p> <p>Ten beeps (Factory Fault) – Follow the returns procedure (see page 111).</p> <p>Twelve beeps (Controller button is stuck) – A button is stuck on the controller. Check no objects are forcing the buttons to be pressed. If not follow the returns procedure (see page 52).</p>
DT01 wireless alarm flashing yellow	DT01 wireless alarm error	<p>When the detector has a general fault, the yellow LED blinks once every four seconds and there is a chirp every 48 seconds. The Controller will go into fault mode if the error state (detector trouble or a dirty detector fault) can affect the operation of Automist:</p> <p>3 yellow flashes every 4 seconds – Freeze warning</p> <p>Yellow flashes every 4 seconds – Detector Trouble</p> <p>Yellow flashes every 12 seconds – Low Battery, please refer to the maintenance section on page.</p> <p>Yellow flashes every 8 seconds – Detector Dirty, please refer to the maintenance section on page 101.</p>
Pump does not run during commissioning although there is power to Automist Smartscan Hydra unit	<p>Trigger alarm not connected to Automist Smartscan Hydra</p> <p>Pump damaged in transit</p>	<p>Check that you have connected the alarm to the spray head using ALARM TEST MODE (see page 94).</p> <p>Perform the commissioning procedure with the appropriate head to pair the alarm.</p> <p>Please contact Plumis technical support.</p>
Power circuit trips out as soon as pump starts	Too-small MCB used for Automist Smartscan Hydra circuit	Please refer to page 61.

Problem	Probable Cause	Recommended Action
After commissioning, water continues to flow from the head even if pump is stopped for over 1 minute	Dirt ingress to solenoid valve stopping it from closing	Connect a short hose from the high pressure outlet into a bucket. Run the pump for at least 30 seconds and ensure the water is clean. Stop pump. Flow must stop as intended. Remove the quick connector to ensure water flow has stopped. If there is a slow flow of water, it will not be immediately noticeable at the sprayhead. Reconnect the quick connector and high pressure hose to the sprayheads
No mist is produced, although pump runs during commissioning test	Loose high-pressure hose, leakage between pump and Automist Smartscan Hydra head Water supply is interrupted	Check for gross leakage on the high-pressure water path, for example the quick-fit connector may not be secured, or its O-ring may not have been fitted. Re-run commissioning. Verify that the isolation valve is open and that there is a water supply to Automist Smartscan Hydra.
	Severe blockage at the pump inlet	Close off the water with the isolation valve. Disconnect the inlet hose and check for blockages on the pump strainer and within the hose.
	Pump damaged in transit	Disconnect the high-pressure hose from the Automist Smartscan Hydra head and re-run the commissioning procedure with the high-pressure hose outlet placed inside a container with volume markings. If volume of water is less than 5.6 litres, the pump is not providing the correct flow. Please contact Plumis technical support.
Either the pressure is above the correct range, or the pump pulses or temporarily cuts out during the commissioning test	High pressure blockage	Disconnect high pressure hose between the Automist Smartscan Hydra head and the pump and check for blockages in the high-pressure line or around the inlet to the spray head. Shut off water at the isolation valve. Remove pump inlet. Flow water into waste to ensure it is clean. Reconnect the pump inlet hose. Run the pump for 30 seconds (activating alarm) to allow solenoid valve to be cleaned. Stop pump. Flow must stop as intended. If the problem persists, contact Plumis technical support.

Problem	Probable Cause	Recommended Action
Water continues to flow through the pump after commissioning or slow leak detected from the spray head	The solenoid valve may have some dirt on it, preventing a secure seal and allowing water to slowly fill the hoses.	<p>Attach a spare hose to the high pressure output and into a bucket or disconnect the hose connection from the spray head and place in a bucket to collect the water. Run the pump again as per commissioning stage 3 to flush any dirt from the solenoid or pump.</p> <p>Remove the high pressure hose and locking pin, dry the area, and observe the outlet for 2 minutes, if no water is expelled from the pump, reconnect the high pressure hose and locking pin. If water is being expelled, replace the pump and contact Plumis.</p>
Holding test and enter does not put the system into commissioning mode	<p>You are trying to access commissioning mode within 12 minutes of completing the commissioning.</p> <p>The controller is in a sleep state</p>	<p>Switch the mains supply off to the pump.</p> <p>Wait 10 seconds</p> <p>Switch the mains supply on to the pump</p> <p>Hold test and enter to go into commissioning stage 1</p>

Plumis UK technical support

If you are unable to resolve your issue you can email technical@plumis.com or call 020 3823 8912 or 07763218682

Returning equipment to Plumis – RMA (Return Material Authorisation)

Before sending equipment to Plumis please conduct an A-B-A test. This process identifies the root cause of the failure mode by removing and replacing one element of the system. Gather evidence (photos & video) that the error can be stopped by introducing one new part, and reconfirm the problem comes back by reintroducing it.

The installer must complete an online Plumis Field Issue Report, located on the Partner site, attaching all the evidence, before sending the equipment back to Plumis.

IMPORTANT! Plumis will not accept any products that are returned without a field issue report.

IMPORTANT! Field Issue reports are necessary so Plumis can replicate and identify the failure mode. They are a fundamental part of an insurance and/or warranty claim.

Warranty

Plumis Ltd offers a parts only warranty for its products to be free from defects under normal residential use for a period of two years from the date that the installation is approved by Plumis. If annual servicing is kept up to date, then this warranty is extended to four years. This warranty is limited to repair or replacement of units returned to Plumis Ltd according to our return procedure. The warranty on any replacement units, will last for the remainder of the period of the original warranty. Plumis Ltd reserves the right to offer an alternative product like that being replaced if the original model is no longer available or in stock.

If the product is found to have failed for reasons outside our warranty cover Plumis may quote to repair the unit and return it. Where products are replaced or repaired under warranty, they will be returned to a UK address free of charge.

This warranty does not cover the removal or reinstallation of products, or faults in installation. Nor does it cover the product which is installed more than 12 months after the original purchase date.

Plumis Ltd must not be liable for any incidental or consequential damages caused by the breach of any expressed or implied warranty. Except to the extent prohibited by applicable law, any implied warranty of merchantability or fitness for a particular purpose is limited in duration for two years. This warranty does not affect your statutory rights.

APPENDIX A

Non-compliance notice			
The Automist can provide fire protection when installed and used in compliance with the manufacturers Design, Installation, Operation and Maintenance (DIOM) Manual. Your installer has identified the following non compliances. Please take the following measures to rectify them.			
Installation Ref	Engineer Name	Date	Type
e.g. BLU234	e.g. Ms Smith	e.g. 01/01/2020	Code compliance or elective upgrade
Address	e.g. Plumis Ltd, Unit 4, Phoenix Trading Estate, Bilton Rd, Perivale, Greenford UB6 7DZ		
Item			
Non-compliance			
Corrective action			
Item			
Non-compliance			
Corrective action			

APPENDIX B

ONSITE COMMISSIONING FORM						
Installation Ref	Engineer Name		Date		Type	
e.g. BLU234	e.g. Ms Smith		e.g. 01/01/2020		Code compliance or elective upgrade	
Address		e.g. Plumis Ltd, Unit 4, Phoenix Trading Estate, Bilton Rd, Perivale, Greenford UB6 7DZ				
Property Type <i>(circle one)</i>	1-2 Storey	3 Storey	4+ Storey	Flat	Other	New Build
	Y/N					
Customer	Name		Email			
	e.g. Mr Hassan Wong		e.g. hassan.chi@hotmail.com			
EQUIPMENT LOG						
Alarm	Location		Brand	Type	Serial no.	
1	e.g. Bedroom 1		e.g. Aico	Wired or wireless	e.g. 2342	
2	e.g. Bedroom 2		e.g. Aico	Wired or wireless	e.g. 2343	
3	e.g. Bedroom 3		e.g. Aico	Wired or wireless	e.g. 2344	
4	e.g. Bedroom 4		e.g. Aico	Wired or wireless	e.g. 2345	
5	e.g. Bedroom 5		e.g. Aico	Wired or wireless	e.g. 2346	
6	e.g. Bedroom 6		e.g. Aico	Wired or wireless	e.g. 2347	
7	e.g. Bedroom 7		e.g. Aico	Wired or wireless	e.g. 2348	
8	e.g. Bedroom 8		e.g. Aico	Wired or wireless	e.g. 2349	
9	e.g. Bedroom 9		e.g. Aico	Wired or wireless	e.g. 2350	
10	e.g. Bedroom 10		e.g. Aico	Wired or wireless	e.g. 2351	
11	e.g. Bedroom 11		e.g. Aico	Wired or wireless	e.g. 2352	
12	e.g. Bedroom 12		e.g. Aico	Wired or wireless	e.g. 2353	
13	e.g. Bedroom 13		e.g. Aico	Wired or wireless	e.g. 2354	
14	e.g. Bedroom 14		e.g. Aico	Wired or wireless	e.g. 2355	
15	e.g. Bedroom 15		e.g. Aico	Wired or wireless	e.g. 2356	
16	e.g. Bedroom 16		e.g. Aico	Wired or wireless	e.g. 2357	
17	e.g. Bedroom 13		e.g. Aico	Wired or wireless	e.g. 2354	
18	e.g. Bedroom 14		e.g. Aico	Wired or wireless	e.g. 2355	
Controller	Location		Serial no.	Software version		
1	e.g. Landing cupboard		e.g. 54354355	e.g. 0.1.01		
2	e.g. Landing cupboard		e.g. 54354355	e.g. 0.1.01		
3	e.g. Landing cupboard		e.g. 54354355	e.g. 0.1.01		
Circuit	Circuit breaker		Protection	Breaker Rating		
1	e.g. C, B, D		e.g. MCB, RCBO, RCD	e.g. 10		
2	e.g. C, B, D		e.g. MCB, RCBO, RCD	e.g. 10		
3	e.g. C, B, D		e.g. MCB, RCBO, RCD	e.g. 10		
Pump	Location	Inlet pressure	Inlet flow rate	Serial no.	Hose Length	Circuit no.
1	e.g. Landing cupboard	e.g. 3 bar	e.g. 3 lpm	e.g. 08456324	e.g. 15 m	1
2	e.g. Landing cupboard	e.g. 3 bar	e.g. 3 lpm	e.g. 08456324	e.g. 15 m	2

3	e.g. Landing cupboard	e.g. 3 bar	e.g. 3 lpm	e.g. 08456324	e.g. 15 m	3
Head	Location		Type	Pressure	Pump no.	
1	e.g. Bedroom 1		e.g. Smartscan Hydra	e.g. 100 bar	1	
2	e.g. Bedroom 1		e.g. Smartscan Hydra	e.g. 100 bar	1	
3	e.g. Kitchen 1		e.g. Smartscan Hydra	e.g. 100 bar	1	
4	e.g. Kitchen 1		e.g. Smartscan Hydra	e.g. 100 bar	1	
5	e.g. Bedroom 2		e.g. Smartscan Hydra	e.g. 100 bar	1	
6	e.g. Bedroom 2		e.g. Smartscan Hydra	e.g. 100 bar	1	
7	e.g. Living room 1		e.g. Smartscan Hydra	e.g. 100 bar	2	
8	e.g. Living room 1		e.g. Smartscan Hydra	e.g. 100 bar	2	
9	e.g. Bedroom 1		e.g. Smartscan Hydra	e.g. 100 bar	2	
10	e.g. Bedroom 1		e.g. Smartscan Hydra	e.g. 100 bar	2	
11	e.g. Kitchen 1		e.g. Smartscan Hydra	e.g. 100 bar	2	
12	e.g. Kitchen 1		e.g. Smartscan Hydra	e.g. 100 bar	2	
13	e.g. Bedroom 2		e.g. Smartscan Hydra	e.g. 100 bar	3	
14	e.g. Bedroom 2		e.g. Smartscan Hydra	e.g. 100 bar	3	
15	e.g. Living room 1		e.g. Smartscan Hydra	e.g. 100 bar	3	
16	e.g. Living room 1		e.g. Smartscan Hydra	e.g. 100 bar	3	
17	e.g. Bedroom 3		e.g. Smartscan Hydra	e.g. 100 bar	3	
18	e.g. Bedroom 3		e.g. Smartscan Hydra	e.g. 100 bar	3	
Notes/deviations						

APPENDIX C

Example Design Specification

- a) **Building/occupancy type**
Three story loft conversion/single dwelling, domestic occupancy
- b) **Areas of the building to be protected**
Throughout, except for the following areas, which may be excluded unless required by a fire strategy or risk assessment:
- bathrooms fitted with a door and with a floor area of less than 5 m²;
 - cupboards and pantries fitted with doors and with a floor area of less than 2 m², and rooms in which the smallest dimension does not exceed 1 m, where the walls and ceilings are covered with non-combustible or limited-combustible materials;
 - non-communicating, attached buildings such as garages, boiler houses, etc.;
- See layout drawing
- c) **Water supply requirements and verification measures**
Minimum flow and pressure recorded on each pump at peak demand: 9 lpm and 2 bar pressure
- d) **How Automist interacts with fire alarm system**
Completely stand alone. Automist's detection is installed alongside a pre-existing LD1 system.
- e) **Details of any enhancements to Automist**
Not applicable
- f) **Where a fire strategy relies upon the design of the automatic water fire suppression system (AWFSS), a version-controlled copy of that fire strategy, including sufficient detail to understand the fire safety objectives, relationships, and dependencies**
See BS 9991 Section 6.5 (see 11.2, Table 2)

APPENDIX D

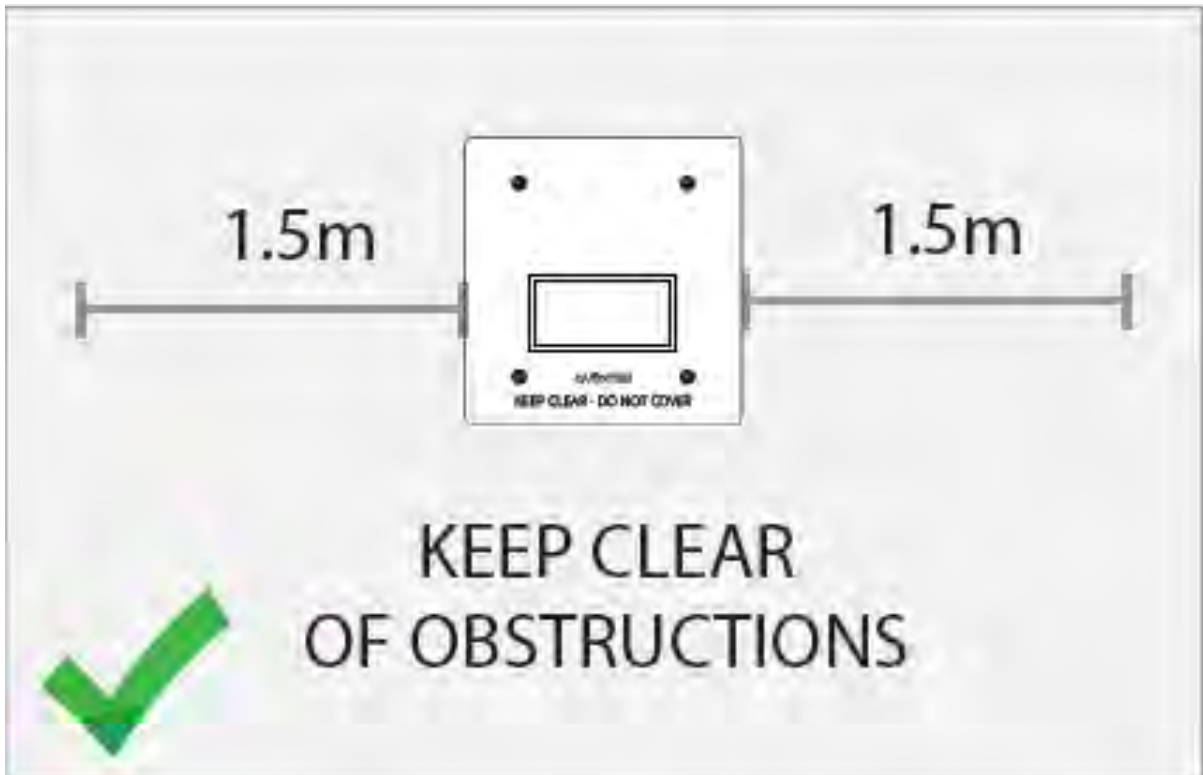

**SMOKE OR
HEAT WILL
MAKE IT SCAN**

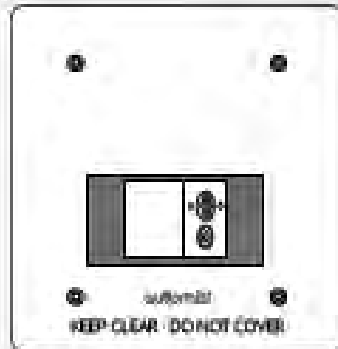

**FIRE WILL
MAKE IT
SPRAY**

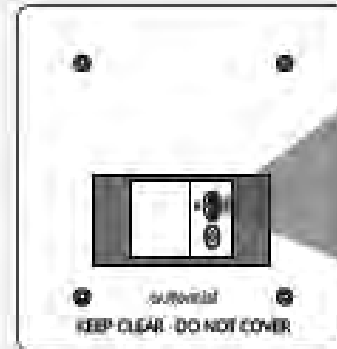

CONTACT

**IF IT IS
BEEPING**



**STOP IT
USING THE
BUTTON**

